

Table of Contents

HEATING SYSTEM PRODUCTS

Technical Specifications	4
Heat Exchangers - Water-to-Air	5-7
Heat Exchangers - Water-to-Water	8-9
Heat Exchangers - Convection	10
Piping - ThermoPEX and CentralPEX	11-12
Circulators	13-14
Manifolds	14-15
Fittings - PEX.....	16
Fittings - Threaded	17
Fittings - Copper / Sweat	18
Fittings - Push-Fit.....	19
Valves	20
Valves / Thermostatic Valves	21
Thermostats / Aquastats.....	22

OUTDOOR FURNACE PRODUCTS

Options & Accessories	23-25
Water Treatment / Firebox Protection	26
Tools.....	27-29
Door & Related.....	30-31
Gas Related	32
Chimney.....	33-35
Original Equipment	36

Alphabetical Index

24 Fan Conversion Kit - Classic Edge/Classic Edge HD	23	Clamp, PEX, 1"	12
24V Fan Conversion Kit - Classic Edge HDX	23	Clamp, Rubber	29
Actuator, Thermal	15	Cleaning Rod - Classic Edge / E-Classic	28
Adapter, Female 1" NPT - for Manifold Kits	14	Cleaning Rod - Maxim	28
Adapter, Female, 3/4" Hose	17	Cleaning Rod Scraper Attachment - Classic Edge / E-Classic	29
Adapter, Female - Copper Pipe	16	Cleaning Tool, Afterburner	28
Adapter, Male, 3/4" Hose	17	Cleaning Tool, Heat Exchanger	28
Adapter, PEX 90° Elbow - Threaded Pipe	16	Clean Out Kit, Battery - Maxim	25
Adapter, PEX 90° Swoop Elbow	16	Conversion Kit, Natural Gas - E-Classic	32
Adapter, PEX - Copper Pipe	16	Cord, Power Supply	14
Adapter, PEX - Threaded Pipe	16	Corn Aerator Kit - Maxim	24
Adapters, Female - Copper	18	Corn Aerator Paddle Kit - Maxim	24
Adapters, Male - Copper	18	Coupling, 25mm PEX	16
Adapters, PEX 90° Elbow	16	Coupling, Brass - 3/4"	17
Adapters, PEX - Copper Pipe	16	Couplings, 1/2" and 1" PEX	16
Adapters, PEX - Threaded Pipe	16	Couplings, Copper	18
Air Filter	6	Cover, Outer Control	23
Air Handler Cabinet	7	Crimp Tool, Universal	27
Antenna Mount Kit, External Wi-Fi	23	Decoiler	27
Aquastat, Fixed	22	Door Rope and Seals - Classic Edge	36
Aquastat, Immersible - Adjustable	22	Door Seal Kits - Classic Edge/E-Classic	30
Aquastat, Pool	22	Door Seal Kits - Classic/Pallet Burner	30
Aquastat, Surface Mount - Adjustable	22	Door Seals - Forge	36
Ash Rake - Classic	28	Door Seal, Silicone-Coated, 100-ft	30
Ash Scoop - Maxim	29	Draft Inducer	30
Ash Shovel - Classic	28	Dual Fuel Burner Kits and Components	32
Ash Shovel - E-Classic	28	Dual Fuel Kits	32
Ash Shovel, Reaction Chamber	28	Elbow, 45° Street	17
Ashtril	26	Elbow, 90° - Copper	18
Auxiliary Auger Kits - Maxim	24	Elbow, 90° - FPT	17
Auxiliary Auger Vibrator w/Timer Kit - Maxim	24	Elbow, 90° Reducing - Copper	18
Backflow Preventer	20	Elbow, 90° Street	17
Bag Holder Kit - Maxim	24	Elbow, 90° Street - 1" Copper	18
Ball Valve	20	Elbow, Vent - Copper	18
Ball Valve, PEX	20	Fan Coil Unit, 50k Btu	7
Ball Valve, Sweat	20	Fan Coil Unit, 100k Btu	7
Baseboard, Complete	10	Fan Coil Unit, 220k Btu	7
Baseboard Corners	10	Fan Convactor (26k Btu)	6
Baseboard End Cap	10	Fan Convactor, Corner (7k Btu)	6
Baseboard Joiner	10	Fan Convactor, Kickspace	7
Blower & Motor	7	Fan Convactor, Wall Mount (7k Btu)	6
Brush, Cleaning	29	Fin Comb	27
Bushing, Hex - NPT	17	FireStar II Wiring Kit	23
Bushing, Reducing - Brass	17	FireStar XP Outdoor Wi-Fi Module Kit	23
Bypass Alarm Kit - Classic Edge 750	23	Fittings, Brass - for 1-1/4" PEX Pipe	16
Cap, Copper End	18	Fittings Kit, Push-fit - for Water-to-Water Heat Exchanger	8
Cap - for Manifold Kits	15	Fittings Kit, Water Heater - for Plate Heat Exchanger	8
Caps, Round Pipe	17	Fittings Kit, Water Heater - for Water-to-Water Heat Exchanger	8
Cartridge, Water Softener	26	Fittings, PEX Brass Clamp	16
Central PEX 1/2" Pipe	11	Flange, 3/4" Isolation - with Drain Valve	14
Central PEX 1" Pipe	11	Flange Kit, Isolation	14
Central PEX 1" Pipe Sections	11	Flange Kits, Pump	14
Check Valve, Flow	20	Flue Brush & Handle	28
Check Valve, Swing - Brass	20	Flue Brush & Handle Kit	28
Chimney Attachment Ring	33	Gas Burner Kits - E-Classic	32
Chimney Band Clamp Kit, 6"	33	Gasket, Ignitor Burner	32
Chimney Band Clamp Kit, 8"	33	Gauges, Temperature	15
Chimney Base Brace Kit, 6"	34	Gauge, Temperature - for Manifold Kits	15
Chimney Base Brace Kit, 8"	34	Grounding Rod Kit	23
Chimney Cap/Spark Arrestor	33	Heat Exchanger Coil (50k Btu)	5
Chimney Cleaning Kit - 6"	28	Heat Exchanger Coil (80k Btu)	5
Chimney Cleaning Kit - 8"	28	Heat Exchanger Coil (95k Btu)	5
Chimney Components	34	Heat Exchanger Coil (100k Btu)	5
Chimney Guy-Wire Band, 6"	33	Heat Exchanger Coil (125k Btu)	5
Chimney Guy-Wire Band Kit, 8"	33	Heat Exchanger Coil (140k Btu)	5
Chimney Rope Ring	35	Heat Exchanger Coil (185k Btu)	5
Chimney Sections, 6"	33	Heat Exchanger Coil (220k Btu)	5
Chimney Sections, 6" - Maxim	33	Heat Exchanger, Domestic Water Heater, Water-to-Water	8
Chimney Sections, 8" - Classic	33	Heat Exchanger, Plate	8
Chimney Sections, 8" - Classic Edge 750/760/960, E-Classic	33	Heat Exchanger, Stainless 316L - for Swimming Pool	9
Chimney Support Brace Kit	34	Heat Exchanger, Titanium - for Swimming Pool	9
Chimney Tee Kits, Stainless Steel	34	Hinge, Rear Door - Kit	31
Chimney Tee Restrictor Kit	34	Hoe, Firebox - Classic	28
Cinch Tool	27	Hopper, 48-Bushel Kit - Maxim	24
Clamp Crimp Ring, PEX Stainless Steel	12	Hopper Extension Kit - Maxim	24
Clamp Crimp Ring Removal Tool	27	Hopper Kit with Fuel Door - M250/M255 P	25
Clamp, Hose, 1" or 1-1/4"	12	Hopper Vibrator Kit - Maxim	24
Clamp, Hose, 25mm	12	Hose Bibs, Brass	20

Alphabetical Index

Hose Bibs, Brass - Straight	20	Tee, Brass - PEX	16
Hose, SP, Braided	11	Tee, Purging and Filling - 3/4"	20
Hose w/Regulator, Propane - Maxim	32	Tee, Reducing - Copper	18
Integrated Cleaning System - Classic Edge	29	Tees, Copper	18
LED Light Kit	23	Tees, NPT	17
LED Light Kit, Secondary	23	ThermoPEX Coupling Kit - 1" and 1-1/4"	11
Linkage	31	ThermoPEX Coupling Kit - 25mm	11
Louvers	6	ThermoPEX Termination Cap	11
Manifold	15	ThermoPEX with 1" or 1-1/4" PEX	11
Manifold Kit Connectors	14	ThermoPEX with 25mm PEX	11
Manifold Kits	14	Thermostatic Valve, 1-1/4"	21
Manifold w/o Valves	15	Thermostatic Valve Fittings Kit, 1-1/4"	21
Manifold w/Valves	15	Thermostatic Valve Fittings Kit, 3/4"	21
Mixing Valve, 1" x 4-way FNPT	21	Thermostatic Valve Kit, 3/4"	21
MolyArmor 350 Corrosion Inhibitor	26	Thermostat Kit	21
Moly/pH Test Kit	26	Thermostat, Line Voltage	22
Mounting Bracket, Plate Heat Exchanger	8	Thermostat , Multi-stage - 24-Volt	22
Mounting Brackets - Swimming Pool Heat Exchangers	9	Thermostat, Plug-in	22
Mounting Kit, PEX Piping	12	Thermostat, Programmable - 24-Volt	22
Mounting Kit, Plate Heat Exchanger	8	Thermostat , Single-stage, Non-programmable - 24-Volt	22
Mounting Kit, Plate Heat Exchanger, 5x12, Universal	8	Torch, Outdoor	27
Mount Kit, Wall - Taco Pump	14	Transfer Auger with Fuel Door Assembly Kit - M175	25
Multimeter, Digital Pocket	27	Transformer, 24-Volt	22
Myson Replacement Items	7	Union, Brass Pipe - FIP	17
Nipple, Black Close	17	Valve, 3-Way	20
Nipple, Black - MPT	17	Valve Bodies, Thermostatic Radiator	10
Nipple, Brass	17	Valve Head, TRV II	10
O-Ring Set	14	Valve, Radiant Mixing	21
Panel Radiators	10	Valve, Tempering	21
PEX 1-1/4" Pipe	11	Valve, Water Heater Mixing	21
PEX Crimp Rings / Crimp Tools	12	Vent Valve, Automatic	20
PEX Hanger	12	Water Sample Bottle Kit	26
PEX Pipe Cutter	27	Water Temperature Indicator Kit, Indoor	23
PEX Piping Clip Gun	27	Water Test Kit	26
PEX Piping Clips	12	Wood Moisture Meter Kit	27
Pin Extraction Tool	27	Wood Moisture Meter, Mini 3-in-1	27
Plug, Pipe - MPT	17	Y-Strainer	8
Plug, Pipe - Wrench Set	27	Zone Valve, 2-Way - Repair Kit	20
Pump, Taco - 006 Series	13	Zone Valve, 3-Way - 24-Volt	20
Pump, Taco - 007 Series	13	Zone Valves, Zone Sentry®	20
Pump, Taco - 009 & 014 Series	13		
Pump, Taco - 0015e3™	13		
Pump, Taco - Replacement Cartridges	13		
Pump, Taco - Viridian VR1816	13		
Pump, Taco - Viridian VT2218	13		
Push-fit - Depth Gauge/Deburring Tool	19		
Push-fit - Disconnect Clip	19		
Push-fit Fitting - Adapter, Male	19		
Push-fit Fitting - Connector, Straight	19		
Push-fit Fitting - Coupling, Reducing	19		
Push-fit Fitting - Female Adapter	19		
Push-fit Fittings - Coupling, Straight	19		
Push-fit Fittings, Elbow	19		
Push-fit Fitting, Tee	19		
Push-fit Fitting - Temperature Gauge	19		
Ratchet Cinch Tool	27		
Reducer, Copper	18		
Regulator Kit, 2-Stage Gas	32		
Relay, 24-Volt	22		
Relay, Fan Center	22		
Rope, Door Seal	30		
Scraper, Heat Exchanger - E-Classic	28		
Scraper Tool	28		
Sediment Trapper Filter, Hot Water, 3/4"	26		
Shut-off with Level Indicator, Propane - Maxim	32		
Sludge Conditioner	26		
Solder & Soldering Flux	29		
Solenoid	31		
Space Heater (100k Btu)	6		
Space Heater (140k Btu)	7		
Space Heater Cabinet (50k Btu)	7		
Space Heater, Suspended (100k Btu)	6		
Suspended Space Heater (220k Btu)	6		
Switching Relay, Single Zone	14		
Tape, Blue Teflon, 1/2" x 1429"	17		
Tee, Brass, 3/4"	17		
Tee, Brass Diverter	18		
Tee, Brass Offset, 4"	17		

Pex Tubing

TECHNICAL SPECIFICATIONS

PEX Tubing Technical Specifications

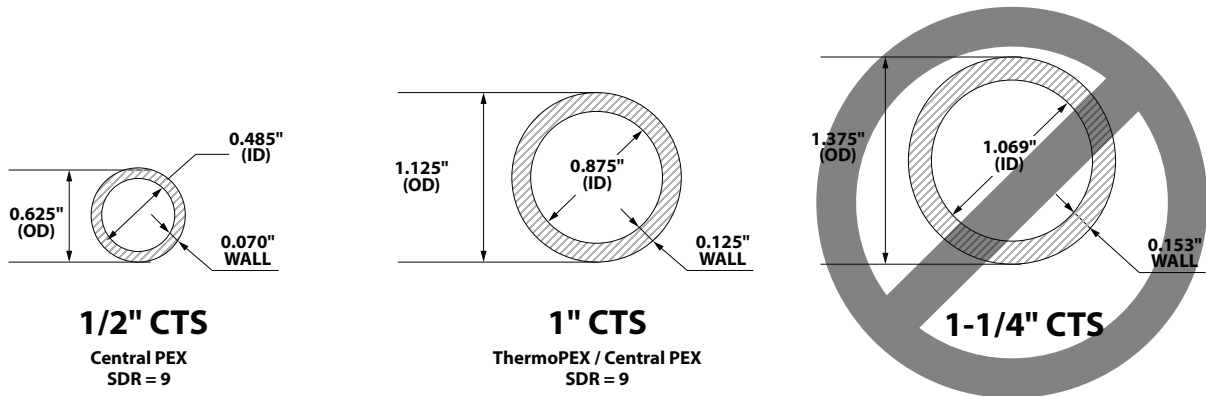

PEX Tubing Size (CTS/Nominal)	Outside Diamer (OD)	Minimum Wall Thickness	Inside Diameter (ID)
1/2"	0.625"	0.070"	0.485"
1"	1.125"	0.125"	0.875
1-1/4"	1.375"	0.153"	1.069"

Notes:

1. PEX tubing sizes are denoted by CTS (copper tubing size), not OD (Outside Diameter) or ID (Inside Diameter).
2. OD of PEX, copper and CPVC pipe with the same size (CTS) is the same. This is why push fittings can be used with all of these pipes.
3. PEX made to US standards must comply with a SDR-9 (Standard Dimension Ratio), which is the ratio of OD (Outside Diameter) to pipe wall thickness (9:1). Exceptions are nominal sizes 1/2" and below.

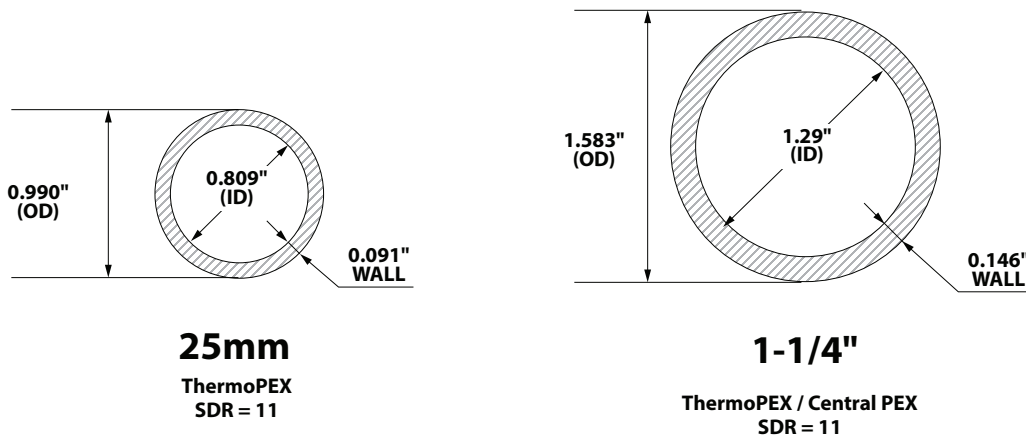

PEX Tubing Size (Nominal)	Outside Diamer (OD)	Minimum Wall Thickness	Inside Diameter (ID)
25mm	0.990"	0.091"	0.809"
1-1/4"	1.583"	0.146"	1.29"

Notes:

1. PEX with a SDR-11 (Standard Dimension Ratio) are NOT compatible with CTS (copper tubing size) fittings.
2. 25mm PEX and 1-1/4" PEX used in ThermoPEX are SDR-11 (Standard Dimension Ratio), which is the ratio of OD (Outside Diameter) to pipe wall thickness (11:1).

Heating System

HEAT EXCHANGERS - WATER-TO-AIR

Water-to-air heat exchanger coils are available in different sizes with different Btu outputs. Be sure to check the dimensions of the coil and the approximate plenum size, in addition to the outlet configuration.

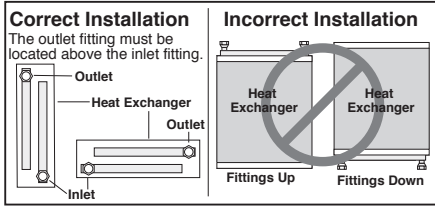

p/n	Output (Btu)	Approx. Plenum Size (in.)	Dimensions			3/4" FPT Outlets
			Length (in.)	Width (in.)	Depth (in.)	
287	50,000	13 x 14	14	12-3/4	4-1/8	90°
109	80,000	13 x 18	18	12-3/4	4-1/8	Straight
102	95,000	15 x 18	20	15	4-1/8	Straight
106	100,000	17 x 18	19	16-1/2	4-1/8	Straight
107	125,000	18 x 18 to 18 x 20	20	17-3/4	4-1/8	Straight
704	125,000	18 x 18 to 18 x 20	20	17-3/4	4-1/8	90°
108	140,000	20 x 20	21	19	4-1/8	Straight
110	185,000	23 x 23	24	19	4-1/8	Straight
111	220,000	24 x 24	26	24	4-1/8	Straight

Heat Exchanger Coil (50k Btu)

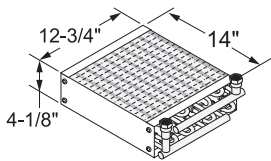

Water-to-air heat exchanger coil with 90° 3/4" female pipe thread (FPT) outlets. Dimensions: 12-3/4" x 14" x 4-1/8".

p/n	Description
287	Heat Exchanger Coil, 50k Btu

Heat Exchanger Coil (80k Btu)

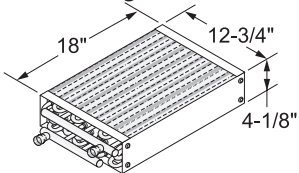

Water-to-air heat exchanger coil with straight 3/4" FPT outlets. Used in forced-air furnaces with plenum size of approximately 13" x 18". Dimensions: 12-3/4" x 18" x 4-1/8".

p/n	Description
109	Heat Exchanger Coil, 80k Btu

Heat Exchanger Coil (95k Btu)

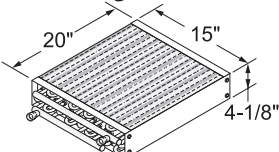

Water-to-air heat exchanger coils with straight 3/4" FPT outlets. Used in forced-air furnaces with plenum size of approximately 15" x 18". Dimensions: 15" x 20" x 4-1/8".

p/n	Description
102	Heat Exchanger Coil, 95k Btu

Heat Exchanger Coil (100k Btu)

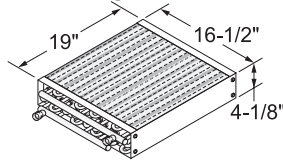

Water-to-air heat exchanger coil with straight 3/4" FPT outlets. Used in forced-air furnaces with plenum size of approximately 17" x 18". Dimensions: 16-1/2" x 19" x 4-1/8".

p/n	Description
106	Heat Exchanger Coil, 100k Btu

Heat Exchanger Coil (125k Btu)

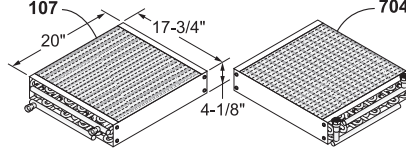

Water-to-air heat exchanger coil with straight (p/n 107) or 90-degree (p/n 704) 3/4" FPT outlets. Used in forced-air furnaces with plenum size from approximately 18" x 18" to 18" x 20". Dimensions: 17-3/4" x 20" x 4-1/8".

p/n	Description
107	Heat Exchanger Coil, 125k Btu, straight outlets
704	Heat Exchanger Coil, 125k Btu, 90° outlets

Heat Exchanger Coil (140k Btu)

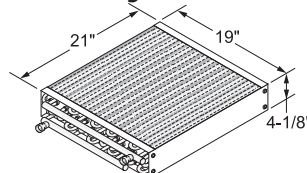

Water-to-air heat exchanger coil with straight 3/4" FPT outlets. Used in forced-air furnaces with plenum size of approximately 20" x 20". Dimensions: 19" x 21" x 4-1/8".

p/n	Description
108	Heat Exchanger Coil, 140k Btu

Heat Exchanger Coil (185k Btu)

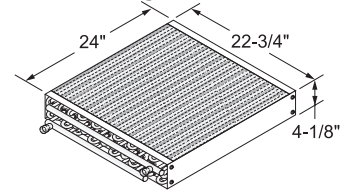

Water-to-air heat exchanger coil with straight 3/4" FPT outlets. Used in forced-air furnaces with plenum size of approximately 23" x 23". Dimensions: 22-3/4" x 24" x 4-1/8".

p/n	Description
110	Heat Exchanger Coil, 185k Btu

Heat Exchanger Coil (220k Btu)

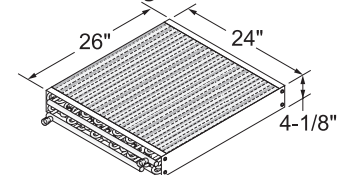

Water-to-air heat exchanger coil with straight 3/4" FPT outlets. Used in forced-air furnaces with plenum size of approximately 24" x 24". Dimensions: 24" x 26" x 4-1/8".

p/n	Description
111	Heat Exchanger Coil, 220k Btu

IMPORTANT INFORMATION ABOUT BTU RATINGS:

Btu outputs and ranges are provided for comparison only. Actual Btu output will vary depending on a number of factors such as flow gpm, airflow cfm and water and air temperatures. Btu ratings assume high input factors and may not be achieved in actual installations and/or configurations with lower input factors.

Heating System

HEAT EXCHANGERS - WATER-TO-AIR

Space Heater, Suspended (100k Btu)

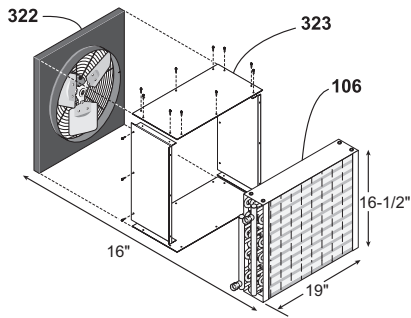

Order the following components for a complete Suspended Space Heater (100k Btu). Some assembly required. Assembled size approximately 19" x 16-1/2" x 16". Allow at least 6" on side for fittings.

p/n	Description
322	Fan
323	Transition
106	Heat Exchanger Coil, 100k Btu

Suspended Space Heater (220k Btu)

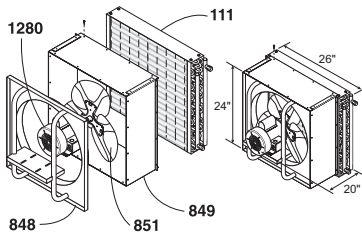

Order the following components for a complete Suspended Space Heater (220k Btu). Some assembly required. Assembled size approximately 26" x 24" x 20". Allow at least 6" on side for fittings.

p/n	Description
111	Heat Exchanger Coil, 220k Btu
849	Transition
848	Motor Frame
851	Fan Blades
1280	Fan Motor

Louvers

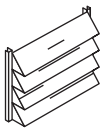

Bolt on to the face of the heat exchanger to direct heat downward.

p/n	Description
355	Louvers, fit Heat Exchanger Coil (p/n 106)
354	Louvers, fit Heat Exchanger Coil (p/n 108)
353	Louvers, fit Heat Exchanger Coil (p/n 111)

Fan Convector (26k Btu)

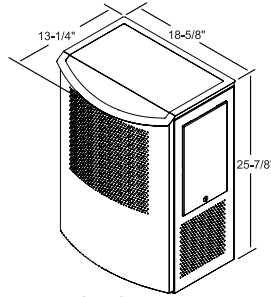

Central Boiler fan-forced convector. Quiet operation, integral filters and thermostat connections. 3/4" FPT fittings and on-off-thermostat switch. Output up to 26,000 Btu/hr. Color - taupe. 24-Volt Thermostat (p/n 588 or 8200008) is optional.

p/n	Description
1971	Fan Convactor, 26k Btu
588	Programmable 24-Volt Thermostat
8200008	Non-programmable 24-Volt Thermostat
956	Elbow, 90-degree, 3/4" x 3/4" (optional)

Replacement Components

342	Switch, ON/OFF
3015	Fan Motor
340	Relay
2500010	Transformer

Fan Convactor, Wall Mount (7k Btu)

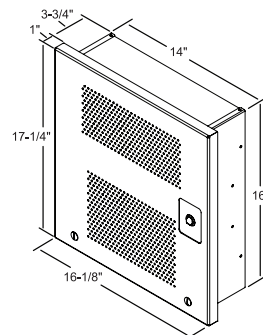

Central Boiler recessed wall, fan-forced convector. Quiet operation, integral filters and thermostat connections. Can use Female Adapter (p/n 6679) or Push-fit Fitting (p/n 606) for connection. 1/2" fittings and on-off-thermostat switch. Output up to 7,000 Btu/hr. 24-Volt Thermostat (p/n 588 or 8200008) is optional.

p/n	Description
1941	Fan Convactor, Wall Mount, 7k Btu
588	Programmable 24-Volt Thermostat
8200008	Non-programmable 24-Volt Thermostat

Replacement Components

342	Switch, ON/OFF
1940	Fan Motor
340	Relay
2500010	Transformer

Fan Convactor, Corner (7k Btu)

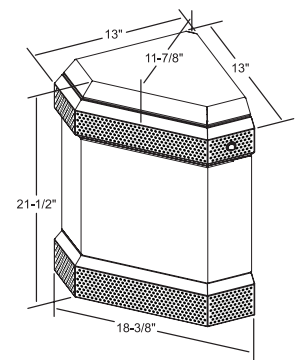

Central Boiler fan-forced convector. Quiet operation, integral filters and thermostat connections. Can use Female Adapter (p/n 6679) or Push-fit Fitting (p/n 606) for connection. 1/2" fittings and on-off-thermostat switch. Output up to 7,000 Btu/hr. 24-Volt Thermostat (p/n 588 or 8200008) is optional.

p/n	Description
1910	Fan Convactor, Corner, 7k Btu
588	Programmable 24-Volt Thermostat
8200008	Non-programmable 24-Volt Thermostat

Replacement Components

342	Switch, ON/OFF
1940	Fan Motor
340	Relay
2500010	Transformer

Air Filter

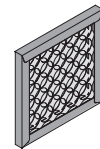

Replacement air filter (10" x 10" x 1") for fan-forced convectors. 1971 convactor requires 2 filters; 1910 and 1941 convectors require 1.

p/n	Description
1938	Air Filter, 10" x 10" x 1"

Space Heater (100k Btu)

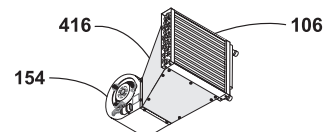

Order the following components for a Space Heater (100k Btu). Some assembly required. Assembled size approximately 19" x 21" x 33".

p/n	Description
416	Transition
154	Blower & Motor, 1/4-hp 3-speed fan
106	Heat Exchanger Coil, 100k Btu

Heating System

HEAT EXCHANGERS - WATER-TO-AIR

Space Heater (140k Btu)

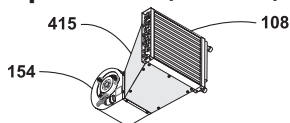

Order the following components for a Space Heater (140k Btu). Some assembly required. Assembled size approximately 19" x 21" x 33".

p/n	Description
415	Transition
154	Blower & Motor, 1/4-hp 3-speed fan
108	Heat Exchanger Coil, 140k Btu

Space Heater Cabinet (50k Btu)

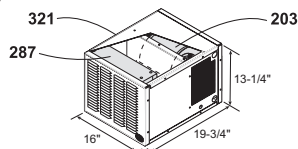

Cabinet for housing 1/15-hp Blower & Motor (p/n 203) and 50k Btu Heat Exchanger Coil (p/n 287). Each sold separately. Some assembly required. Dimensions: 16" x 19-3/4" x 13-1/4".

p/n	Description
321	Space Heater Cabinet

Blower & Motor

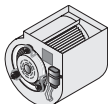

Blower & Motor assemblies.

p/n	Description
203	Blower & Motor, 1/15-hp
154	Blower & Motor, 1/4-hp, 3-speed fan
208	Blower & Motor, 1-hp, 3-speed fan

p/n 203 1/15 hp 115V	CFM (cubic feet per minute)						
	FREE AIR	1/8" SP	1/4" SP	3/8" SP	1/2" SP	3/4" SP	1" SP
1530 rpm (1-speed)	465	430	397	357	308	N/A	N/A

p/n 154 1/4 hp 115V	CFM (cubic feet per minute)				
	FREE AIR	1/4" SP	1/2" SP	3/4" SP	1" SP
LOW speed	708	808	800	593	194
MED. speed	963	1063	1020	708	224
HIGH speed	1353	1349	1287	1014	250

p/n 208 1 hp 115V	CFM (cubic feet per minute)					
	1.2" SP	1.3" SP	1.4" SP	1.5" SP	1.6" SP	1.7" SP
LOW speed (1038 rpm)	2248	2143	2032	1890	1085	1498
MED. speed (1070 rpm)	2480	2373	2218	2084	1910	1696
HIGH speed (1097 rpm)	2701	2522	2373	2231	2057	1851

SP=static pressure, hp=horsepower

Fan Coil Unit, 50k Btu

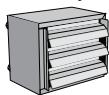

50k Btu fan coil unit (3/4" FIP) includes housing, fan, heat exchanger coil and louvers. Btu range: 20k-50k Btu. Approximate dimensions: 16-1/4" x 17" x 13-1/4". Motor: 70 watts. Approximately 588 cfm.

p/n	Description
2900544	Fan Coil Unit, 50k Btu
2900610	Replacement Fan, motor and shield, 50k Btu, for 29000544

Fan Coil Unit, 100k Btu

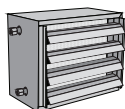

100k Btu fan coil unit (3/4" FIP) includes housing, fan, heat exchanger coil and louvers. Btu range: 40k-100k Btu. Approximate dimensions: 21" x 19" x 17". Motor: 180 watts. Approximately 1,352 cfm.

p/n	Description
2900545	Fan Coil Unit, 100k Btu
2900611	Replacement Fan, motor and shield, 100k Btu, for 29000545

Fan Coil Unit, 220k Btu

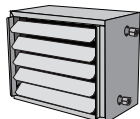

220k Btu fan coil unit (3/4" FIP) includes housing, fan, heat exchanger coil and louvers. Btu range: 80k-220k Btu. Approximate dimensions: 31" x 18" x 25". Motor: 330 watts. Approximately 2,823 cfm.

p/n	Description
2900546	Fan Coil Unit, 220k Btu
2900612	Replacement Fan, motor and shield, 220k Btu, for 29000546

Air Handler Cabinet

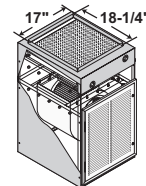

Two sizes allow multiple applications from 100k Btu to 220k Btu; cabinets are standard with front water access (refer to the chart below for specific applications).

NOTE: Blower & Motor and Heat Exchanger Coil are sold separately. Air Handler Cabinet door is capable of holding a filter (not included). Some assembly will be required. If utilizing an existing 24-volt thermostat to control blower, a Fan Center Relay (p/n 515) must be used.

p/n	Dimensions (in.)	Heat Exch. Coil Range	Blower & Motor	Water Access
301	36 x 20 x 23	100k-140k Btu	1/4-hp	Front
		Filter (not included): 16 x 20		
303	39 x 25 x 28	185k-220k Btu	1-hp	Front
		Filter (not included): 20 x 20		

p/n	Description
301	Air Handler Cabinet, 100k-140k Btu, front access
3822	Kit for 301 - back water access
303	Air Handler Cabinet, 185k-220k Btu, front access
3825	Kit for 303 - back water access

Fan Convector, Kickspace

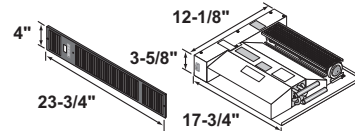

Myson Whispa™ III Kickspace 9000 fan-forced convector, output of 7,634-9,949 Btu/hr. Dimensions: 17-3/4" x 12-1/8" x 3-5/8". Weight: 15 lb. Fan speed (cfm): boost - 124, normal - 82. Cover grill is 4" x 23-3/4".

p/n	Description
5600000	Myson Whispa III Kickspace 9000 Fan Convector

Myson Replacement Items

Replacement items for Myson fan convectors not listed here.

p/n	Description
210	Fan/Motor Assembly for 6773 Myson Whispa II Kickspace 9000 Fan Convector
211	Fan/Motor Assembly for 6771

Heating System

HEAT EXCHANGERS - WATER-TO-WATER

Heat Exchanger, Plate

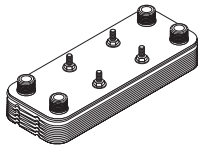

The Plate Heat Exchanger is a compact, high-performance, water-to-water, continuous flow heat exchanger with MPT ports. Units are 316L stainless, copper-brazed.

p/n	Typical Application
5600003	Water heaters
5744	Boilers up to 100k Btu
5600001	Boilers 100k-175k Btu
5600002	Boilers 175k-250k Btu
5600019	Applications up to 760k Btu

p/n	Description
5600003	Plate Exchanger, 5 x 12-6, 3/4" Port
5744	Plate Exchanger, 5 x 12-30, 1" Port
5600001	Plate Exchanger, 5 x 12-50, 1-1/4" Port
5600002	Plate Exchanger, 5 x 12-70, 1-1/4" Port
5600019	Plate Exchanger, 10 x 20-55, 1-1/4" Port

NOTE: Also see Swimming Pool Heat Exchangers (p/n 5600005 through 5600015).

Mounting Bracket, Plate Heat Exchanger



Mounts most 5" x 12" Plate Heat Exchangers (30 or less) with mounting studs to a wall or similar surface.

p/n	Description
5807-011	Plate Mounting Bracket

Mounting Kit, Plate Heat Exchanger

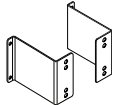

Mounts most 5x12 Plate Heat Exchangers (40 or more) with mounting studs to a wall or similar surface. Includes two mounting brackets.

p/n	Description
2500299	Heat Exchanger Mounting Kit

Mounting Kit, Plate Heat Exchanger, 5x12, Universal

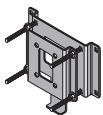

Universal mounting kit for 5x12 plate exchangers.

p/n	Description
1097	Universal 5x12 Plate Heat Exchanger Mounting Kit

Y-Strainer

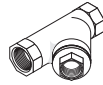

Y-Strainer with 0.20 mesh and FIP fittings. Recommended when installing plate-style heat exchangers. For 3/4" Y-Strainer, use 1/2" Brass Pipe Plug (p/n 6557) for cleanout port. For 1" Y-Strainer, use 3/4" Brass Pipe Plug (p/n 574) for cleanout port.

p/n	Description
1695	Y-Strainer, 3/4" Brass
573	Y-Strainer, 1" Brass
1694	Y-Strainer, 1-1/4" Black

Fittings Kit, Water Heater - for Plate Heat Exchanger

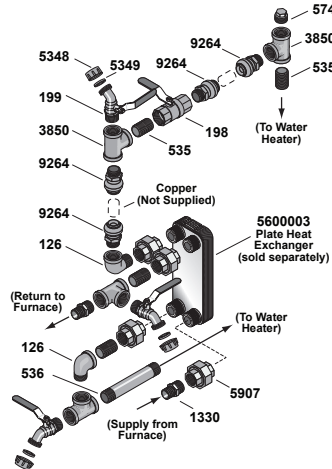

For domestic water heaters using Plate Heat Exchanger (p/n 5600003).

p/n	Description
2500013	Fittings Kit, threaded ports

Heat Exchanger, Domestic Water Heater, Water-to-Water

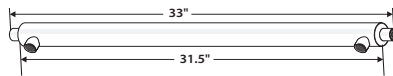

The Water-to-Water Heat Exchanger is a stainless steel water-to-water, domestic water heat exchanger with 3/4" FIP end and side ports. Install on existing water heater for thermal circulating heat transfer. Fittings Kit (p/n 2053) or Push-fit Fittings Kit (9263) are available separately for easy installation.

p/n	Description
5600018	Water-to-Water Heat Exchanger, 33"

Fittings Kit, Water Heater - for Water-to-Water Heat Exchanger

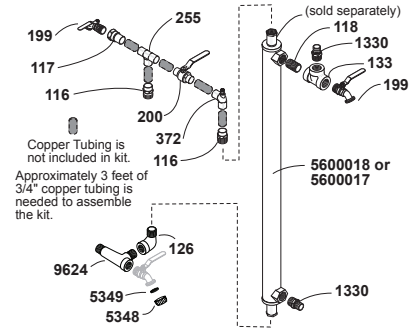

Used to install the Water-to-Water Heat Exchanger (p/n 5600018 or 5600017) on existing domestic water heater for thermal circulating heat transfer. Water-to-water heat exchanger is sold separately.

p/n	Description
2053	Fittings Kit

Fittings Kit, Push-fit - for Water-to-Water Heat Exchanger

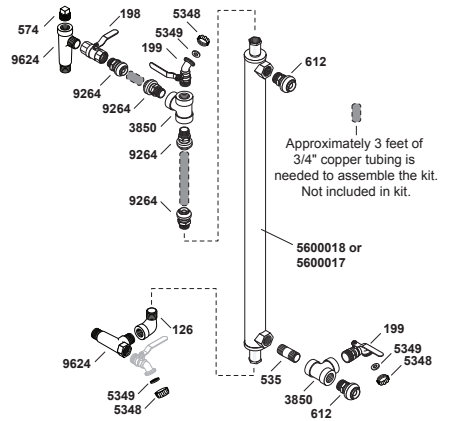

Used to install the Water-to-Water Heat Exchanger (p/n 5600018 or 5600017) on existing domestic water heater for thermal circulating heat transfer. Water-to-water heat exchanger is sold separately.

p/n	Description
9263	Push-fit Fittings Water Heater Kit

Heat Exchanger, Stainless 316L - for Swimming Pool

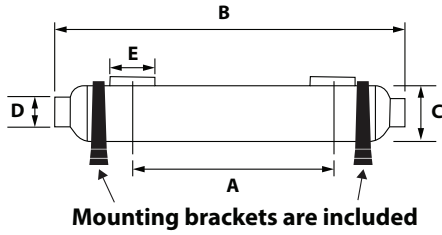

Stainless steel exchangers are used as hot tub or swimming pool heat exchangers. Other applications include snow melt or solar heating. *Not recommended for use with salt chlorinated pools or hot tubs.*

Mounting brackets are included for horizontal or vertical mounting. Should always be installed with the mounting bracket fixed to a wall, ceiling or floor to prevent damage from vibrations or water hammer.

p/n	Btu Rating	Pool Capacity (U.S. gallons)
5600005	55,000	3,960
5600006	155,000	11,900
5600007	300,000	23,800
5600008	360,000	29,000
5600009	600,000	47,500
5600010	1,200,000	95,100

Exchanger Dimensions

p/n	A (in.)	B (in.)	C (in.)	D (in.)	E (in.)
5600005	7.6	13.3	2.5	1	3/4
5600006	9.2	15.9	3.1	1	1-1/2
5600007	20.5	27.6	3.1	1-1/2	2
5600008	28	35	3.1	1-1/2	2
5600009	25.4	33.9	4.3	2	2-1/2
5600010	25.9	35.2	5	2	2-1/2

p/n	Description
5600005	Pool Heat Exchanger, 316L, 55k Btu
5600006	Pool Heat Exchanger, 316L, 155k Btu
5600007	Pool Heat Exchanger, 316L, 300k Btu
5600008	Pool Heat Exchanger, 316L, 360k Btu
5600009	Pool Heat Exchanger, 316L, 600k Btu
5600010	Pool Heat Exchanger, 316L, 1200k Btu

Heat Exchanger, Titanium - for Swimming Pool

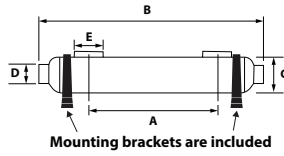

Titanium heat exchangers are ideal for swimming pools with salt water or where salt generator/chlorinators are used.

Mounting brackets are included for horizontal or vertical mounting. Should always be installed with the mounting bracket fixed to a wall, ceiling or floor to prevent damage from vibrations or water hammer.

p/n	Btu Rating	Pool Capacity (U.S. gallons)
5600011	55,000	3,960
5600012	155,000	11,900
5600013	300,000	23,800
5600014	360,000	29,000
5600015	600,000	47,500

Exchanger Dimensions

p/n	A (in.)	B (in.)	C (in.)	D (in.)	E (in.)
5600011	7.6	13.3	2.5	1	3/4
5600012	9.2	15.9	3.1	1	1-1/2
5600013	20.5	27.6	3.1	1-1/2	2
5600014	28	35	3.1	1-1/2	2
5600015	25.4	33.9	4.3	2	2-1/2

p/n	Description
5600011	Pool Heat Exchanger, Titanium, 55k Btu
5600012	Pool Heat Exchanger, Titanium, 155k Btu
5600013	Pool Heat Exchanger, Titanium, 300k Btu
5600014	Pool Heat Exchanger, Titanium, 360k Btu
5600015	Pool Heat Exchanger, Titanium, 600k Btu

Mounting Brackets - Swimming Pool Heat Exchangers



Replacement mounting brackets for Stainless 316L and Titanium Swimming Pool Heat Exchangers. Includes two mounting brackets.

p/n	Description
3104665	Mounting Bracket, 55k Btu Pool Heat Exchangers
3104940	Mounting Bracket, 155k/300k/360k Btu Pool Heat Exchangers
3104941	Mounting Bracket, 600k Btu Pool Heat Exchangers
3104942	Mounting Bracket, 1200k Btu Pool Heat Exchangers

Heating System

HEAT EXCHANGERS - CONVECTION

Panel Radiators

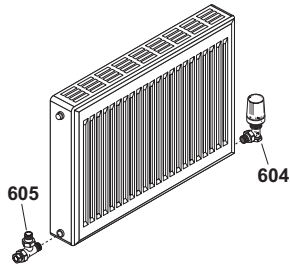

Type 21G Double Panel Single Convecter and Type 22G Double Convecter panel radiators in various sizes and Btu output. Valves (p/n 604, 605 are sold separately).

p/n	Baseboard Equivalent	Output (Btu/hr)	Fan Convecter Equivalent
5600021	6 feet	3,789	N/A
5600022	10 feet	5,643	6777, 6774, 6839
5600023	14 feet	7,361	6780
603	18 feet	9,286	6773
5600025		7,100	
5600026		2,839	
5600027		5,679	
5600028		4,440	

- No electricity required, no thermostats, no extra pumps
- Easy installation - includes mounting bracket and thread sealer

p/n	Description
5600021	Panel Radiator, 32" x 16"
5600022	Panel Radiator, 36" x 24"
5600023	Panel Radiator, 48" x 24"
603	Panel Radiator, 55-1/4" x 24"
5600025	Panel Radiator, 36" x 24"
5600026	Panel Radiator, 24" x 16"
5600027	Panel Radiator, 48" x 16"
5600028	Panel Radiator, 32" x 20"

Valve Bodies, Thermostatic Radiator

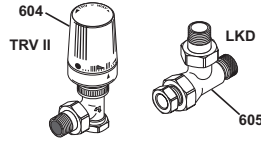

Each valve body is threaded for nominal iron pipe threads and also comes with a compression nut and ferrule. Replacement head only is part number 5000378.

p/n	Description
604	TRV II Valve Body and Head, 1/2" Vertical
605	LKD Valve Body with No Cap, 1/2" Preset Flow Rate

Valve Head, TRV II



Replacement valve head for 604 TRV II Valve Body and Head, 1/2" vertical.

p/n	Description
5000378	Valve Head, 1/2" Vertical, TRV II

Baseboard, Complete

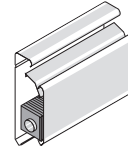

Each baseboard includes heating element and cover. Rated 610 Btu/ft at 180°F water temperature. Flow rate of 4 gal/min, 3/4" copper sweat fittings. End caps, joiners and corners sold separately.

p/n	Description
234	Baseboard, Complete, 2'
235	Baseboard, Complete, 3'
236	Baseboard, Complete, 4'
237	Baseboard, Complete, 5'
238	Baseboard, Complete, 6'

Baseboard End Cap



Left or right Baseboard End Caps for radiant baseboard water heater.

p/n	Description
232	Baseboard End Cap, Left
233	Baseboard End Cap, Right

Baseboard Corners

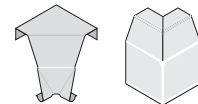

Inside and outside Baseboard Corner covers for radiant baseboard water heater.

p/n	Description
182	Baseboard Corner, Inside
183	Baseboard Corner, Outside

Baseboard Joiner



Used to cover joints in continuous lengths of baseboard.

p/n	Description
230	Baseboard Joiner

Heating System

PIPING - THERMOPEX AND CENTRALPEX

ThermoPEX with 1" or 1-1/4" PEX



ThermoPEX is flexible pre-insulated piping consisting of two waterproof oxygen barrier PEX-A lines (supply and return) protected by polyurethane closed cell foam insulation and a thick, durable, waterproof polyethylene outer jacket. It is the ideal insulated piping for use with outdoor wood furnaces. The outside diameter of 1" ThermoPEX is 4-3/8"; 1-1/4" ThermoPEX has an outside diameter of 5".

Available with 1" Central PEX in 100-ft, 200-ft or 800-ft rolls, or with 1-1/4" PEX in 100-ft or 300-ft rolls.

p/n	Description
2441	ThermoPEX, 1", 100' Roll
5700034	ThermoPEX, 1", 200' Roll
2491	ThermoPEX, 1", 800' Roll
2799	ThermoPEX, 1-1/4", 100' Roll
2492	ThermoPEX, 1-1/4", 300' Roll

ThermoPEX Coupling Kit - 1" and 1-1/4"



Twelve-inch rubber splice is used to join two ends of ThermoPEX together. Includes band clamps. Fittings and crimp rings for joining the PEX lines are sold separately.

p/n	Description
2447	ThermoPEX Coupling Kit, 1"
2495	ThermoPEX Coupling Kit, 1-1/4"
1333	PEX Coupling, 1"
381	Brass Coupling, 1-1/4" barb x 1-1/4" barb

ThermoPEX with 25mm PEX



ThermoPEX with two 25mm waterproof oxygen barrier PEX-A lines (supply and return) is more flexible and easier to haul and ship. It's ideal for shorter runs and for the do-it-yourselfers. The outside diameter of 25mm ThermoPEX is 2-15/16".

The 55' roll (p/n 5700047) is UPS shippable.

All rolls except the 500' roll can be shipped via Spee-Dee.

p/n	Description
5700047	ThermoPEX, 25mm, 55' Roll
5700043	ThermoPEX, 25mm, 60' Roll
5700046	ThermoPEX, 25mm, 95' Roll
5700045	ThermoPEX, 25mm, 500' Roll

ThermoPEX Coupling Kit - 25mm

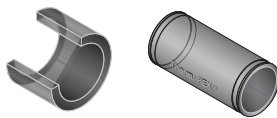

Twelve-inch rubber splice is used to join two ends of ThermoPEX together. Includes band clamps. Fittings and crimp rings for joining the PEX lines are sold separately.

p/n	Description
2500172	ThermoPEX Coupling Kit, 25mm

ThermoPEX Termination Cap



Fits snugly over each end to protect and seal the insulation from water. Includes band clamps.

p/n	Description
5500014	ThermoPEX Cap, 25mm
2443	ThermoPEX Cap, 1"
2494	ThermoPEX Cap, 1-1/4"

Hose, SP, Braided



For making flexible connections on the furnace.

p/n	Description
2900410-SP	Hose, Braided, 3/4" x 18"
2900411-SP	Hose, Braided, 3/4" x 24"

Central PEX 1/2" Pipe



High-density, oxygen barrier PEX-B, cross-link pipe. Rated for temperatures to 180°F at 100 psi. Available in rolls up to 1000 ft long. Excellent for radiant floor heating applications.

p/n	Description
1320	Central PEX 1/2" Pipe, 300'
1321	Central PEX 1/2" Pipe, 500'
1322	Central PEX 1/2" Pipe, 1000'

Central PEX 1" Pipe



High-density, non-oxygen barrier PEX-B, cross-link pipe, rated for temperatures to 180°F at 100 psi.

p/n	Description
1311	Central PEX 1" Pipe, 100'
1312	Central PEX 1" Pipe, 200'
1313	Central PEX 1" Pipe, 300'
1314	Central PEX 1" Pipe, 500'

Central PEX 1" Pipe Sections

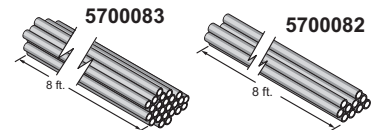

Central PEX 1" Pipe, non-oxygen barrier PEX-B, in straight 8-ft sections.

p/n	Description
5700082	Central PEX 1" Pipe, 8' straight section, 10 per bag
5700083	Central PEX 1" Pipe, 8' straight section, 25 per bag

PEX 1-1/4" Pipe



High-density, oxygen barrier PEX-A, cross-link pipe, rated for 180°F.

p/n	Description
5670	PEX 1-1/4" Pipe, 150'
386	PEX 1-1/4" Pipe, 328'

Heating System

PIPING - THERMOPEX AND CENTRALPEX

Clamp, Hose, 1" or 1-1/4"



1", or 1-1/4" stainless steel hose clamp.

p/n	Description
5978	Central Boiler Clamp, 1"
1745	Central Boiler Clamp, 1-1/4"

Clamp, Hose, 25mm



25mm stainless steel hose clamp.

p/n	Description
5000638	PEX Stainless Steel Hose Clamp, 25mm

Clamp, PEX, 1"



1" Stainless Steel PEX Clamps are excellent alternatives to the 5978 1" Stainless Steel Hose Clamps.

p/n	Description
5000380	1" Stainless Steel PEX Clamp

PEX Crimp Rings / Crimp Tools



PEX Crimp Ring for PEX pipe. Crimp Tool (p/n 145) required for 1" crimp ring.

p/n	Description
1342	PEX Crimp Ring, 1/2"
1335	PEX Crimp Ring, 1"
145	Crimp Ring Tool, 1"

Clamp Crimp Ring, PEX Stainless Steel



For use with Central PEX pipe. Install with Cinch Tool (p/n 5925) or Ratchet Cinch Tool (p/n 4472).

p/n	Description
5000465	PEX Stainless Steel Clamp Crimp Ring, 25mm
5927	PEX Stainless Steel Clamp Crimp Ring, 1/2"
5926	PEX Stainless Steel Clamp Crimp Ring, 1"

Mounting Kit, PEX Piping

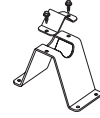

Used to secure 1" PEX and copper pipe. Includes base, top bracket and two screws.

p/n	Description
1360	PEX Piping Mounting Kit

PEX Piping Clips

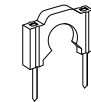

Clips used in PEX Piping Clip Gun (p/n 2900002). Qty. 100.

p/n	Description
2900003	PEX Piping Clips, 100 qty.

PEX Hanger

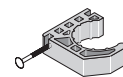

Half-moon, nail-in PEX Hanger for securing PEX piping. Available in two sizes.

p/n	Description
293	PEX Hanger, 1/2"
295	PEX Hanger, 1"

Pump, Taco - 006 Series

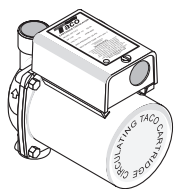

Taco 006 Bronze Circulation Pump for domestic water systems. No flange required, 3/4" sweat connection. Power Supply Cord (p/n 556) sold separately.

size	hp	Amp	Watt	Head (ft)	Volume (gal/min)
006	1/40	0.52	59.8	9	10

p/n	Description
175	Taco 006 Bronze Pump

Pump, Taco - 007 Series

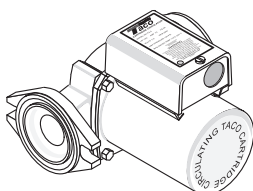

Taco 007 Circulation Pump requires flange kit (not included). Includes O-rings. Power Supply Cord (p/n 556) sold separately.

size	hp	Amp	Watt	Head (ft)	Volume (gal/min)
007	1/25	0.70	80.50	11	20
007 Priority	1/25	0.70	81.65	11	20

p/n	Description
5800004	Taco 007 Pump
5800011	Taco 007 Priority Pump

Pump, Taco - 009 & 014 Series

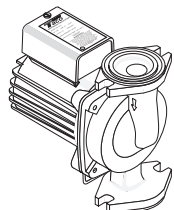

Taco 009 and Taco 014 Circulation Pumps both require flange kit (not included). Includes O-rings. Power Supply Cord (p/n 556) sold separately.

size	hp	Amp	Watt	Head (ft)	Volume (gal/min)
009	1/8	1.40	161	34	8
014	1/8	1.55	178	22	32

p/n	Description
5800006	Taco 009 Pump
5800008	Taco 014 Pump

Pump, Taco - Replacement Cartridges

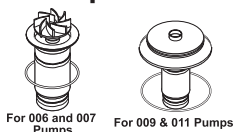

Replacement cartridges for Taco 006, 007, 009, 011 and 014 series pumps. Each includes a 3-year warranty. O-Ring set (p/n 5800034) is for replacement cartridge for 007 or 009 Series Pumps only.

p/n	Application
222	Replacement Cartridge, 006 Series Pumps
5800005	Replacement Cartridge, Bronze, 007 Series Pumps
5800007	Replacement Cartridge, 009 Series Pumps
5800034	O-Ring, Cartridge, Taco 007/009 (set of 2)
5800010	Replacement Cartridge, Bronze, 011 Series Pumps
5800009	Replacement Cartridge, 014 Series Pumps

Pump, Taco - Viridian® VR1816

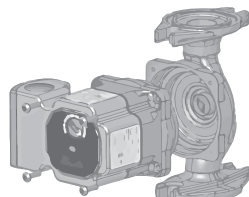

The Taco Viridian VR1816 pump is an infinitely-variable speed, high-efficiency wet rotor circulator with an ECM permanent magnet motor.

- Infinitely-variable fixed speed to fine-tune any zone
- Self-adjusting contact pressure for zone valve applications
- Self-adjusting proportional pressure for panel radiators and thermostatic radiator valves
- 115V, 60 Hz single phase
- 1590-4830 RPM

Model	Max. Amp	Watt	Max. Shutoff Head (ft)	Max. Flow (gal/min)
VR1816F	0.54	4-44	18	16

p/n	Description
5800023	Taco Viridian Pump, VR1816F

Pump, Taco - Viridian® VT2218



The Taco Viridian VT2218 pump is a temperature sensing, variable speed wet rotor circulator with an ECM permanent magnet motor. Operating modes include Delta-T differential temperature, 4 fixed speeds, set point heat, set point cool and boiler protection.

- Delta-T operation maximizes system efficiency and comfort
- High-efficiency ECM motor uses up to 85% less electricity
- LCD displays operating mode, temperature or speed setting, watts, supply & return temperatures
- Easy to program and install
- 110-120V, 50/60 Hz single phase
- 1650-4200 RPM

Model	Max. Amp	Watt	Max. Shutoff Head (ft)	Max. Flow (gal/min)
VT2218F	0.67	9-58	22	18

p/n	Description
5800025	Taco Viridian Pump, VT2218
5800041	Replacement Temp. Sensor

Pump, Taco - 0015e3™

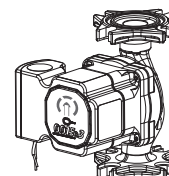

The 0015e3 is a variable speed, high-efficiency wet rotor circulator with an ECM permanent magnet motor. It's ideal for hydronic systems zoned with circulators or zone valves. With three easy settings, the 0015e3 delivers performance, reliability and ease-of-installation.

- Bio Barrier® protects the pump from system contaminants
- SureStart™ automatic unblocking and air purging mode
- High-efficiency ECM motor uses up to 85% less electricity
- IFC® (Integral Flow Check) is included
- 3 easy settings: LOW (5 ft head), MEDIUM (10 ft head) HIGH (18 ft head); 16 gpm max flow
- Dual electrical knockouts and 6" stranded wire leads for no-fumble wiring
- Double insulated; no ground wire needed
- Whisper quiet operation

Model	Max. Amp	Watt	Max. Shutoff Head (ft)	Max. Flow (gal/min)
0015e3	0.54	44	18	16

p/n	Description
5800033	Pump, Taco 0015e3

Heating System

CIRCULATORS / MANIFOLD

Cord, Power Supply



May be used to wire pumps when installed on furnaces. Power Supply Cord (p/n 556) Includes strain relief; Power Supply Cord (p/n 555) does not.

p/n	Description
556	Power Supply Cord, 32"
555	Power Supply Cord, 48"

Flange Kit, Isolation

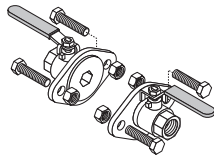

Kit includes flanges, nuts and bolts. Full port, valved flange body.

p/n	Description
224	"Free Floating" Flange Kit, 3/4"
225	Isolation Flange Kit, 1-1/4"

Flange, 3/4" Isolation - with Drain Valve

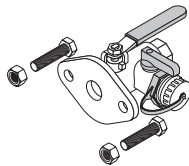

Includes flange, nuts and bolts.

p/n	Description
226	Isolation Flange with Drain Valve, 3/4"

NOTE: Price is for one flange only.

Flange Kits, Pump

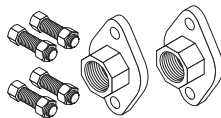

Each kit includes set of two female iron pipe (FIP) pump flanges. One set is used with each pump. Most installations use Pump Flange Kit, 3/4" (p/n 119).

p/n	Description
119	Pump Flange Kit, 3/4"
194	Pump Flange Kit, 1"
5800019	Pump Flange Kit, 1-1/4"

O-Ring Set



Replacement O-rings for Taco pump flange.

p/n	Description
542	O-Ring Set

Mount Kit, Wall - Taco Pump

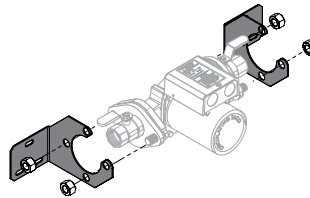

Brackets for supporting and securing Taco pump and flanges to a wall. Figure shows one possible installation scenario. Pump, flanges and mounting hardware are not included.

p/n	Description
1366	Pump Wall Mount Kit

Switching Relay, Single Zone



The SR501 single zone switching relay can easily replace any brand made by any manufacturer, and will even fit into the existing metal enclosure without rewiring incoming connections. The SR501 single zone switching relay is UL and CSA listed, uses a standard "ice cube" replaceable relay and is compatible with conventional and programmable thermostats. External indicator lights provide instant diagnostic feedback, making a snap of service calls or new installation start-ups.

p/n	Description
8200291	Switching Relay, Single Zone

Manifold Kits

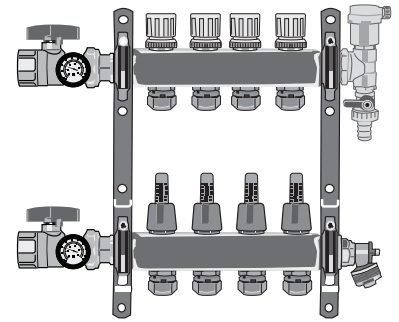

4-Loop shown for illustration purposes

Commonly used for radiant floor heat systems, stainless steel radiant manifold kits are available in various loop configurations for use with 1/2" PEX*.

Each kit includes:

- See-through body flow meters with adjustable flow rates
- Isolation ball valves with 1" NPT fitting
- Temperature gauge for each isolation valve
- Automatic float vent
- 1/2" PEX compression connectors*
- Mounting brackets

p/n	Description
2900552	Manifold Kit, 2-Loop
2900553	Manifold Kit, 3-Loop
2900554	Manifold Kit, 4-Loop
2900556	Manifold Kit, 6-Loop
2900558	Manifold Kit, 8-Loop
2900560	Manifold Kit, 10-Loop
2900562	Manifold Kit, 12-Loop
5000673	O-Ring, Manifold

*Kits include 1/2" PEX compression connectors and O-rings. Additional O-rings (p/n 5000673), 1/2" PEX compression connectors (p/n 2900563) or connectors for PEX-AL-PEX (p/n 2900564) can be ordered separately (see Manifold Kit Connectors).

Manifold Kit Connectors



For use with Stainless Steel Radiant Manifold Kits.

p/n	Description
2900563	Connector, Compression, 1/2" PEX
2900564	Connector, Compression, 1/2" PEX-AL-PEX - ONLY FOR ALUMINUM CORE PEX

Adapter, Female 1" NPT - for Manifold Kits



For use with Stainless Steel Radiant Manifold Kits.

p/n	Description
2900614	Adapter, Manifold, Female 1" NPT

Cap - for Manifold Kits



Manifold Loop Cap can be used with Stainless Steel Radiant Manifold Kits.

p/n	Description
2900551	Loop Cap, Manifold

Gauge, Temperature - for Manifold Kits



Manifold Temperature Gauge can be used with Stainless Steel Radiant Manifold Kits.

p/n	Description
2900596	Temperature Gauge, Manifold

Actuator, Thermal

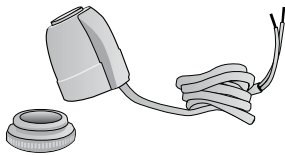

Optional Thermal Actuator (compatible with Stainless Steel Radiant Manifold Kits) is available with either 2-wire or 4-wire configuration. 2-wire provides individual loop flow control on multi-zoned manifold. 4-wire also features end switch for activation of a pump.

p/n	Description
2900549	Thermal Actuator, 2-wire
2900550	Thermal Actuator, 4-wire

Manifold w/Valves

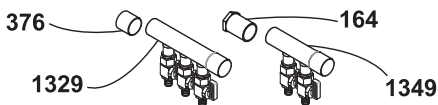

For use with 1/2" PEX pipe in radiant floor installations. Available in a 2- or 3-loop configuration. Manifold fittings are 1" copper sweat; valve fittings are 1/2" barbed.

p/n	Description
1349	Manifold w/Valves, 2-Loop
1329	Manifold w/Valves, 3-Loop
376	Copper Cap, 1"

Manifold w/o Valves



For use with 1/2" PEX pipe in radiant floor installations. Available in a 2- or 3-loop configuration. Manifold fittings are 1" copper sweat; valve fittings are 1/2" barbed. Does not include valves or caps.

p/n	Description
1880	Manifold w/o Valves, 2-Loop
1885	Manifold w/o Valves, 3-Loop

Manifold

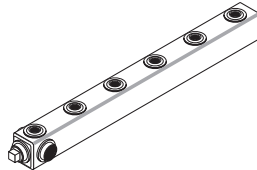

Manifold features two 1-1/4" fittings, six 3/4" FIP fittings and two 1-1/4" bungs (one at each end) for large building system. Manifold measures 3" x 3" x 33-1/2".

p/n	Description
395-011	Manifold

Manifold

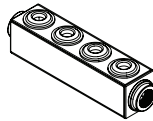

Manifold features 1-1/4" inlet and four 3/4" outlets. Manifold measures 3-1/4" x 3-1/4" x 12-1/4".

p/n	Description
1200033-011	Manifold, 1-1/4" Inlet x 3/4" Outlets

Manifold

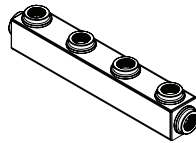

Manifold features 1-1/4" inlet and four 1-1/4" outlets. Manifold measures 3-1/4" x 3-1/4" x 19".

p/n	Description
1200034-011	Manifold, 1-1/4" Inlet x 1-1/4" Outlets

Gauges, Temperature

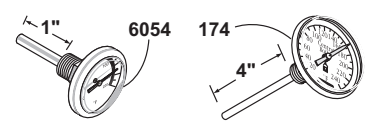

In-line, dial temperature gauge with 1/2" MPT (p/n 174) is optional for manifold, pool heater systems, etc. Gauge (p/n 6054) is 1/8" MPT, 1" diameter with 1" stem length, for use in tight areas.

p/n	Description
6054	Temp. Gauge, 1/8" MPT
174	Temp. Gauge, 1/2" MPT

Heating System

FITTINGS - PEX

Fittings , PEX Brass Clamp

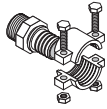

Brass adapter clamps for PEX pipe.

p/n	Description
5642	Brass Clamp Fittings, 1"
5643	Brass Clamp Fittings, 1-1/4"

Coupling, 25mm PEX



For coupling two 25mm Central PEX pipe ends.

p/n	Description
5000462	PEX Coupling, 25mm

Couplings, 1/2" and 1" PEX



For coupling two Central PEX pipe ends.

p/n	Description
1339	PEX Coupling, 1/2"
1333	PEX Coupling, 1"

Fittings, Brass - for 1-1/4" PEX Pipe

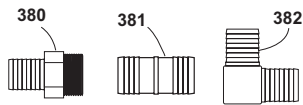

Brass fittings for 1-1/4" PEX pipe. To ease installation, it is recommended that a heat gun be used on the 1-1/4" PEX pipe.

p/n	Description
380	Male Adapter, 1-1/4" barb x 1-1/4" MIP
381	Brass Coupling, 1-1/4" barb x 1-1/4" barb
382	Brass Elbow, 1-1/4" barb x 1-1/4" barb

Adapters, PEX - Threaded Pipe



For adapting threaded pipe to Central PEX pipe.

p/n	Description
1341	PEX Adapter, 1/2" PEX x 1/2" MIP fittings
1336	PEX Adapter, 1/2" PEX x 3/4" MIP fittings
1330	PEX Adapter, 1" PEX x 3/4" MIP fittings
1324	PEX Adapter, 1" PEX x 1" MIP fittings

Adapters, PEX - Copper Pipe



For adapting copper pipe to Central PEX pipe.

NOTE: The 1331 PEX Adapter can also be used for 3/4" sweat applications by sweating the fitting inside.

p/n	Description
1337	PEX Adapter, 1/2" PEX x 1/2" sweat fitting
1331	PEX Adapter, 1" PEX x 3/4" or 1" sweat fitting
1348	PEX Adapter, 1/2" PEX x 1/2" FIP fitting

Adapter, PEX - Copper Pipe



For adapting copper pipe to Central PEX pipe.

p/n	Description
5000651	PEX Adapter, 1" PEX x 1" sweat fitting

Adapter, PEX - Threaded Pipe



p/n	Description
5000464	PEX Adapter, 25mm x 3/4" MIP

Adapter, Female - Copper Pipe

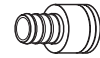

Adapts 1/2" copper pipe to 1/2" Central PEX pipe. Sweat end fits over copper pipe.

p/n	Description
6679	Female Adapter, 1/2" barb x 1/2" sweat fittings

Adapters, PEX 90° Elbow



For coupling two Central PEX pipe ends together.

p/n	Description
1340	PEX 90° Elbow, Brass, 1/2"
1334	PEX 90° Elbow, Brass, 1"

Adapter, PEX 90° Elbow - Threaded Pipe



For coupling 1" Central PEX pipe to 3/4" MPT threaded pipe.

p/n	Description
5000531	PEX Adapter, 1" PEX x 3/4" MPT fittings, 90° Elbow

Adapter, PEX 90° Swoop Elbow

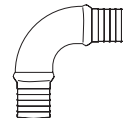

1" stainless steel PEX 90° swoop (sweep) elbow.

p/n	Description
5000768	PEX Swoop Elbow, 90°

Tee, Brass - PEX



Brass tee for joining Central PEX pipe ends.

p/n	Description
1338	PEX Tee, 1/2"
1332	PEX Tee, 1"

Heating System FITTINGS - THREADED

Bushing, Hex - NPT



Hex bushing with national pipe threads (NPT).

p/n	Description
388	Hex Bushing, 1-1/4" x 3/4"
105	Hex Bushing, 1-1/2" x 3/4"
412	Hex Bushing, 1-1/4" x 1/2"
325	Hex Bushing, 3/4" x 1/2"
180	Hex Bushing, 3/4" x 1/8"
408	Hex Bushing, 1-1/2" x 1-1/4"

Bushing, Reducing - Brass



Brass NPT reducing bushing.

p/n	Description
385	Brass Hex Bushing, 1-1/2" x 3/4"
3851	Brass Hex Bushing, 1-1/4" x 3/4"
3042	Brass Hex Bushing, 1/2" x 1/8"

Union, Brass Pipe - FIP



Suggested for use with plate-style heat exchanger installations.

p/n	Description
5907	Brass Pipe Union, 3/4"
5908	Brass Pipe Union, 1"
5909	Brass Pipe Union, 1-1/4"

Plug, Pipe - MPT



Pipe Plug, MPT, black, unless noted.

p/n	Description
331	Pipe Plug, 3/4"
574	Pipe Plug, Brass 3/4"
383	Pipe Plug, 1-1/4"
6557	Pipe Plug, Brass 1/2"

Nipple, Black Close



Nipple (p/n 118) is used with pumps and ball valves. All nipples listed here are Schedule 80, extra heavy.

p/n	Description
118	Nipple, 3/4" x close, Schedule 80, extra heavy
409	Nipple, 1-1/4" x close, Schedule 80, extra heavy
314	Nipple, 1-1/2" x close, Schedule 80, extra heavy

Nipple, Black - MPT

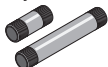

Extra-heavy male pipe thread (MPT) nipples.

p/n	Description
533	Nipple, 3/4" x 2"
534	Nipple, 3/4" x 7"
11157	Nipple, Schedule 80, Black, 1-1/4" x 3"
5000015	Nipple, Schedule 80, Black, 1-1/4" x 2-1/2"
5000018	Nipple, Schedule 80, Black, 3/4" x 3"

Nipple, Brass

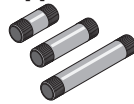

Brass nipples, 3/4" in varying lengths..

p/n	Description
535	Nipple, Brass, 3/4" x 2"
536	Nipple, Brass, 3/4" x 7"
5000394	Nipple, Brass, 3/4" x 4"

Caps, Round Pipe



p/n	Description
332	3/4" Round Pipe Cap
333	1-1/4" Round Pipe Cap

Tees, NPT



Black Tee (p/n 133) can be used for vent option near pump. Brass Tee (p/n 3850) can be used in domestic water situations. Black Tee (p/n 418) can be used to install 1-1/4" thermostatic valve.

p/n	Description
133	Tee, Black, 3/4" NPT
3850	Tee, Brass, 3/4" NPT
418	Tee, Black, 1-1/4" NPT

Tee, Brass, 3/4"

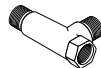

Brass Tee, 3/4" male x female x male. Mainly used for installing heat exchanger on water heater when push-fit fittings are used.

p/n	Description
9624	Tee, Brass, 3/4"

Tee, Brass Offset, 4"



Can be used in conjunction with the Temperature Gauge (p/n 174 or p/n 6054) for monitoring furnace supply water temperature, or may be used instead of Nipple (p/n 533) and 90° Street Elbow (p/n 274) on supply and/or return bung.

p/n	Description
6764	Brass Offset Tee, 4"

Elbow, 45° Street



NPT 45° Street Elbow (black).

p/n	Description
124	45° Street Elbow, 3/4"
5000017	45° Street Elbow, 1-1/4"

Elbow, 90° Street



90° Street Elbow in different sizes.

p/n	Description
411	90° Street Elbow, 1-1/4"
274	90° Street Elbow, 3/4"
126	90° Street Elbow, Brass, 3/4"

Elbow, 90° - FPT



90° Elbow with female threads.

p/n	Description
956	90° Elbow, 3/4" x 3/4" FPT
5000016	90° Elbow, Black, 1-1/4"

Coupling, Brass - 3/4"



Brass Coupling with 3/4" threaded fittings.

p/n	Description
5367	Brass Coupling, 3/4" thread

Adapter, Female, 3/4" Hose

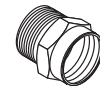

p/n	Description
4928	Brass Adapter, 3/4" female hose x 3/4" male pipe

Adapter, Male, 3/4" Hose

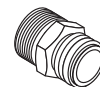

p/n	Description
4929	Brass Adapter, 3/4" male hose x 3/4" male pipe

Tape, Blue Teflon, 1/2" x 1429"



Compatible with a broad range of piping materials. Will not harden or crack on joint. Acts as a thread lubricant and anti-seize. No curing time, unlimited shelf life.

p/n	Description
10713	Tape, Blue Teflon, 1/2" x 1429"

Heating System

FITTINGS - COPPER / SWEAT

Elbow, 90° Street - 1" Copper



90° street elbow with 1" female sweat fitting on one end and 1" male sweat fitting on the other.

p/n	Description
103	Street Elbow, 1"

Couplings, Copper

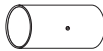

p/n	Description
146	Copper Coupling, 3/4" sweat x 3/4" sweat fittings
147	Copper Coupling, 1" sweat x 1" sweat fittings

Adapters, Male - Copper



p/n	Description
116	Male Adapter, 3/4" sweat x 3/4" MIP fittings
120	Male Adapter, 1" sweat x 1" MPT fittings

Adapters, Female - Copper



p/n	Description
164	Female Adapter, 1" sweat x 3/4" FIP fittings
117	Female Adapter, 3/4" sweat x 3/4" FIP fittings

Tees, Copper

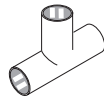

p/n	Description
138	Tee, Copper Pipe, 1" x 1" x 1" sweat fittings
255	Tee, Copper Pipe, 3/4" x 3/4" x 3/4" sweat fittings

Tee, Reducing - Copper



p/n	Description
178	Reducing Tee, 1-1/2" x 1" x 1" sweat fittings

Cap, Copper End



p/n	Description
376	Copper End Cap, 1" sweat fitting

Elbow, Vent - Copper



p/n	Description
372	Vent Elbow, 3/4" x 3/4" sweat fittings
112	Vent Elbow, 1" x 1" sweat fittings

Reducer, Copper



p/n	Description
231	Reducer, Copper Pipe, 1" x 3/4" sweat fittings

Elbow, 90° Reducing - Copper



p/n	Description
123	90° Reducing Elbow, Copper Pipe, 1" x 3/4" sweat fittings

Elbow, 90° - Copper



p/n	Description
276	90° Elbow, Copper Pipe, 3/4" x 3/4" sweat fittings
277	90° Elbow, Copper Pipe, 1" x 1" sweat fittings

Tee, Brass Diverter

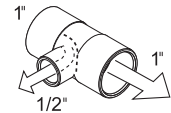

The diverter tee is an excellent sweat fitting used mainly with fan-forced heaters.

p/n	Description
6782	Brass Diverter Tee, 1" x 1" x 1/2"

Heating System FITTINGS - PUSH-FIT

Push-fit Fittings are designed to simplify pipe installation. The fittings allow the user to connect pipe in seconds with relative ease.

- Instant push-fit connection for increased ease-of-use.
- No soldering, clamps, unions or glue required.
- Lead-free
- Fits copper tubing and PEX piping and connects in any combination.

Push-fit Fittings - Coupling, Straight

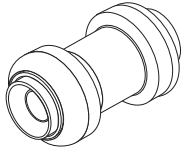

- p/n**
606
607
608
- Description**
Push-fit Coupling, Straight, 1/2" x 1/2"
Push-fit Coupling, Straight, 3/4" x 3/4"
Push-fit Coupling, Straight, 1" x 1"

Push-fit Fitting - Coupling, Reducing

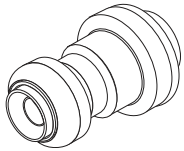

- p/n**
609
- Description**
Push-fit Coupling, Reducing, 1" x 3/4"

Push-fit Fitting - Female Adapter

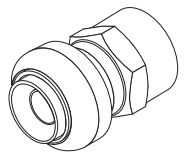

- p/n**
611
- Description**
Push-fit Female Adapter, 1" x 1" FPT

Push-fit Fitting - Adapter, Male

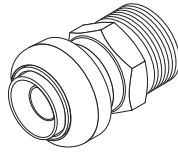

- p/n**
612
- Description**
Push-fit Male Adapter, 1" x 3/4" MPT

Push-fit Fitting - Connector, Straight

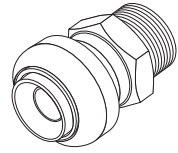

- p/n**
9264
- Description**
Push-fit Connector, Straight, 3/4" x 3/4" MIP

Push-fit Fittings, Elbow

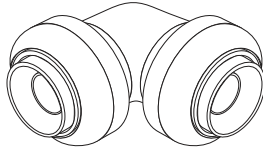

- p/n**
613
9265
- Description**
Push-fit Elbow, 1" x 1"
Push-fit Elbow, 3/4" x 3/4"

Push-fit Fitting, Tee

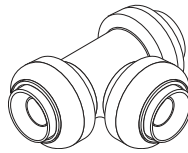

- p/n**
614
- Description**
Push-fit Tee, 1" x 1" x 1"

Push-fit Fitting - Temperature Gauge



1/8" MPT Temperature Gauge (p/n 6054) installs on Temperature Gauge Fitting and fitting installs on push-fit fitting Tee (p/n 614).

- p/n**
1350
- Description**
Push-fit Temperature Gauge Fitting, 1" x 1/8" NPT

Push-fit - Depth Gauge/Deburring Tool

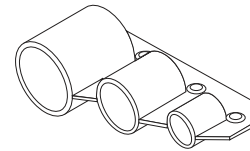

Deburs pipe and used to mark pipe to indicate when the pipe is inserted completely into the fitting. One tool for 1/2", 3/4" and 1" pipe.

- p/n**
615
- Description**
Push-fit Depth Gauge/Deburring Tool

Push-fit - Disconnect Clip

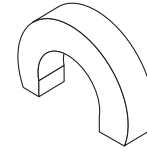

Used to disconnect push-fit fittings quickly and easily.

- p/n**
616
617
618
- Description**
Push-fit Disconnect Clip, 1/2"
Push-fit Disconnect Clip, 3/4"
Push-fit Disconnect Clip, 1"

Heating System VALVES

Zone Valves, Zone Sentry™

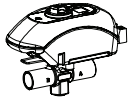

On-off, normally open or normally closed control in open and closed hydronic systems. Simple to install and operate, the valve can be installed in any direction, in any orientation. Snap-in quick connects make for a simple and secure wiring hook-up. LED shows full functionality of the valve's operation and thermostat status. Uses half the power of the 560 Series Zone Valves. 2-way or 3-way zone valves available.

p/n	Description
5800021	3-Way Zone Sentry Zone Valve, 3/4" NPT threads
5800030	3-Way Zone Sentry Zone Valve, 3/4" sweat
5800028	3-Way Zone Sentry Zone Valve, 1" sweat
5800020	2-Way Zone Sentry Zone Valve, 3/4" NPT threads
5800027	2-Way Zone Sentry Zone Valve, 1" sweat
5800022	Replacement Acuator Head for Sentry Zone Valve

Zone Valve, 3-Way - 24-Volt

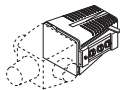

Replacement head for 114 and 127 3-Way Zone Valves (valves no longer available). Can also be used as a replacement head for 571 and 671 2-way zone valves.

p/n	Description
113	Replacement Head

Zone Valve, 2-Way - Repair Kit

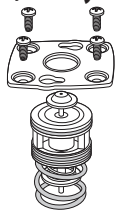

Includes valve body, spring, plate and screws.

p/n	Description
2900401	Repair Kit, 2-Way Zone Valve, 3/4" and 1"

Hose Bibs, Brass



Brass hose bib, 3/4" MPT. Use brass cap (p/n 5348) with washer (p/n 5349) to cover end.

p/n	Description
199	Brass Hose Bib, 3/4" MPT
5349	Washer, 3/4"
5348	Cap, Brass, 3/4"

Hose Bibs, Brass - Straight

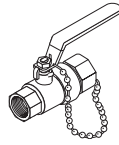

Straight brass hose bib with cap and chain, 3/4" FIP x 3/4" hose. For use as drain valve on some furnaces. For E-Class 3250/3200 models. Will also require 1 each of nipple (p/n 118).

p/n	Description
5000700	Brass Hose Bib w/Cap and Chain, 3/4" FIP x 3/4" Hose

Ball Valve

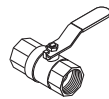

Brass FIP Ball Valves. The 3/4" Full Port Ball Valve (p/n 198) is used on both sides of the pump and on the furnace for each water line.

p/n	Description
186	Ball Valve, 1/2"
198	Ball Valve, 3/4" Full Port - Lead Free
5000661	Ball Valve, 1"
410	Ball Valve, 1-1/4"

Tee, Purging and Filling - 3/4"

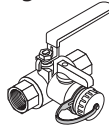

Used to fill system and purge system of air.

p/n	Description
5000083	Purge Tee, Drain, Brass, 3/4" female

Valve, 3-Way

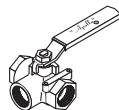

Manually operated, FIP, brass 3-Way Valve.

p/n	Description
330	3-Way Valve, Brass 3/4" FIP

Ball Valve, Sweat

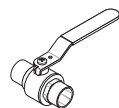

p/n	Description
200	Sweat Ball Valve, 3/4" x 3/4" sweat fitting - Lead Free

Ball Valve, PEX



Full port ball valve for Central PEX.

p/n	Description
5000556	Ball Valve, 1/2" PEX, Full Port
5000557	Ball Valve, 1" PEX, Full Port

Check Valve, Swing - Brass



Brass Swing Check Valve with FIP fittings prevents reverse circulation.

p/n	Description
296	Brass Swing Check Valve, 3/4"
5871	Brass Swing Check Valve, 1-1/4"

Check Valve, Flow

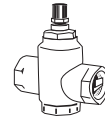

Used in hydronic heating to prevent ghost flow when the components are above the manifold. 1" threaded FNPT x FNPT connections.

p/n	Description
5000670	Flow Check Valve, 1" Cast Iron

Vent Valve, Automatic



Vents air automatically. For use in pressurized systems only. Fitting is 1/8" NPT.

p/n	Description
286	Automatic Vent Valve

Backflow Preventer

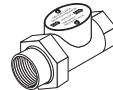

Backflow Preventer used to protect water supplies from contamination. Cast bronze body and brass union inlet connection. LEAD FREE.

p/n	Description
5000472	Backflow Preventer, LF, 3/4"

Heating System VALVES / THERMOSTATIC VALVES

Valve, Tempering

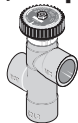

Mixing valve for tempering hot water, with an adjustable temperature range between 120-160°F.

p/n	Description
140	Tempering Valve, 3/4" sweat fittings

Valve, Radiant Mixing

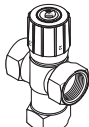

For controlling water temperature in various types of radiant heat systems. Temperature range 70°F - 145°F. Not an anti-scald valve and not intended to be used on water heaters.

p/n	Description
306	Radiant Mixing Valve, 1/2" NPT fittings
327	Radiant Mixing Valve, 3/4" NPT fittings
329	Radiant Mixing Valve, 1" NPT fittings

Valve, Water Heater Mixing

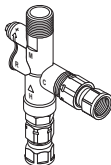

Designed specifically for water heaters, with a temperature range of 90°F - 130°F.

p/n	Description
5000392	Water Heater Mixing Valve, 3/4" NPT fittings, lead free

Mixing Valve, 1" x 4-way FNPT

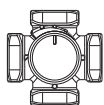

This unit mixes high-temperature boiler water with heated return water to create tempered water for radiant systems and other applications. It is manually operated.

p/n	Description
64026	Mixing Valve, 1" x 4-way FNPT

Thermostatic Valve Kit, 3/4"

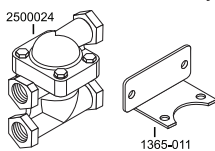

Thermostatic Valve prevents the water temperature from dropping below the optimal operating temperature.

p/n	Description
2500024	3/4" NPT Thermostatic Valve Kit
1365-011	Mounting Bracket for 3/4" NPT Thermostatic Valve

Thermostatic Valve Fittings Kit, 3/4"

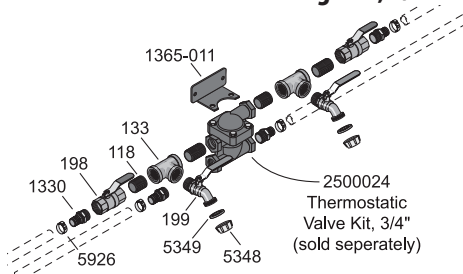

For 3/4" Thermostatic Valve (p/n 2500024).

p/n	Description
1548	3/4" NPT Thermostatic Valve Fittings Kit

Thermostatic Valve, 1-1/4"

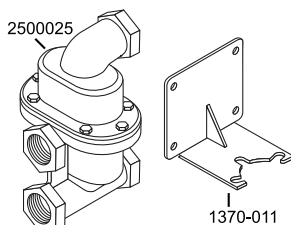

Thermostatic Valve prevents the water temperature from dropping below the optimal operating temperature.

p/n	Description
2500025	1-1/4" NPT Thermostatic Valve
1370-011	Mounting Bracket for 1-1/4" NPT Thermostatic Valve

Thermostatic Valve Fittings Kit, 1-1/4"

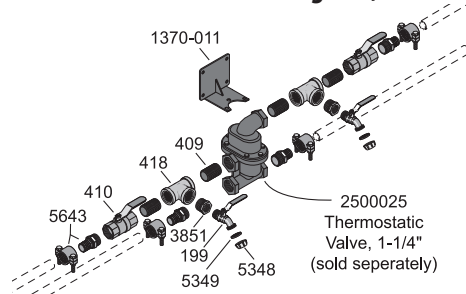

For 1-1/4" Thermostatic Valve (p/n 1621).

p/n	Description
1624	1-1/4" NPT Thermostatic Valve Fittings Kit

Thermostat Kit



Replacement thermostat for thermostatic valve kits. Includes gasket and instructions. Note that for the 1-1/4" thermostatic valve, two thermostats are required.

p/n	Description
1740	Thermostat Kit, 150°F

Heating System

THERMOSTATS / AQUASTATS

Thermostat, Line Voltage



Line Voltage Thermostat (120-volt) used to start the fan on forced-air systems.

p/n	Description
1267	Line Voltage Thermostat

Relay, 24-Volt

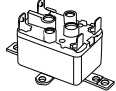

Used to connect a 24-volt thermostat to existing thermostat for a heat pump.

p/n	Description
8200293	Power Relay, 24V, SPNO-SPNC

Relay, Fan Center

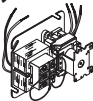

The Fan Center Relay is used to control a 110-volt fan with a 24-volt thermostat.

p/n	Description
515	Fan Center Relay

Thermostat, Programmable - 24-Volt



Can be used in conjunction with zone valves, zone pumps and forced-air systems or used to operate 24-volt 3-way zone valves (requires 24-volt transformer).

p/n	Description
588	Programmable 24-Volt Thermostat

Thermostat, Single-stage, Non-programmable - 24-Volt



Can be used in conjunction with zone valves, zone pumps and forced-air systems or used to operate 24-volt 3-way zone valves (requires 24-volt transformer).

p/n	Description
8200008	Non-programmable 24-Volt Thermostat

Thermostat, Multi-stage - 24-Volt

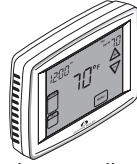

Large, easy-to-read screen allows homeowners to use one thermostat to control up to three stages of heat and two stages of cooling. Fully programmable. Must be installed and wired by a qualified service technician.

p/n	Description
587	Multi-stage 24-Volt Thermostat

Thermostat, Plug-in

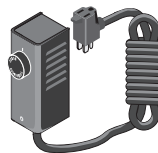

Plug-in Thermostat, 13.5-amp rated, 110-Volt, is for operating fan.

p/n	Description
368	Plug-in Thermostat

Transformer, 24-Volt

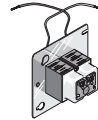

Used with 24-volt wall thermostat and 24-volt zone valves.

p/n	Description
188	24-Volt Transformer

Aquastat, Pool

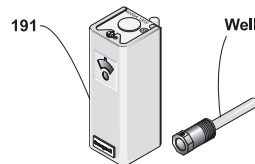

For controlling water temperature in pools, spas, etc., Immersible, temperature range of 40-180°F in one-degree differential. Well sold separately. With pool or hot tub applications, it is recommended to use a stainless steel well (p/n 1248), also sold separately.

p/n	Description
191	Pool Aquastat, 1/2" NPT fitting
1247	Well, 1/2" NPT fitting
1248	Well, Stainless Steel, 1/2" NPT fitting

Aquastat, Immersible - Adjustable

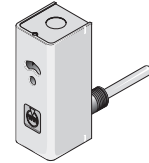

Adjustable between 110-240°F, immersible, with 1/2" MPT fittings on well (either close on rise or open on rise). Well is included with aquastat. Recommended operating setting is between 165-195°F. Can be installed on Classic model furnaces prior to serial number 25151 that were manufactured with a fixed aquastat.

p/n	Description
169	Adjustable Aquastat with Well, 1/2" MPT

Aquastat, Surface Mount - Adjustable



For 1992 and older Classic outdoor wood furnaces, adjustable from 100-240°F.

p/n	Description
204	Adjustable Aquastat

Aquastat, Fixed

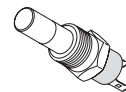

Non-adjustable, immersible, 1/2" MPT fitting.

p/n	Description
290	Fixed Aquastat, 175°F
399	Fixed Aquastat, 190°F

Heating System OPTIONS & ACCESSORIES

FireStar XP Outdoor Wi-Fi Module Kit

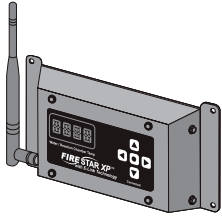

Outdoor Wi-Fi wireless display can be used to remotely view operational data on the FireStar II controller. Compatible only with a properly configured FireStar II equipped outdoor furnace (with software version 6.4x or higher on E-Classic or Classic Edge models, or 2.5x or higher on Maxim M255 PE models).

Kit includes FireStar XP Outdoor Wi-Fi Module, antenna, wiring, Quickstart Guide, Operator's Manual and installation instructions.

NOTE: Wireless range varies widely with each installation. Prior to purchase, a site survey (using a smartphone or laptop) should be performed to determine if the furnace site is within range of existing Wi-Fi network. Range is generally up to 100 feet when unobstructed and there is no interference. Uses 802.11 technology.

E-CLASSIC/CLASSIC EDGE

p/n	Description
2500070	FireStar XP Outdoor Wi-Fi Module Kit
8200080	Wi-Fi Antenna only

MAXIM M255 PE

p/n	Description
2500185	FireStar XP Outdoor Wi-Fi Module Kit
8200080	Wi-Fi Antenna Only

FireStar II Wiring Kit

Some earlier E-Classic models require this wiring kit in order to be able to monitor the bypass door and gas-fired wood ignition over the internet.

p/n	Description
2500023	FireStar II Wiring Kit

Antenna Mount Kit, External Wi-Fi

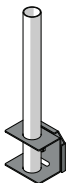

Used to mount a wi-fi antenna (not included) to the lift tab of the furnace.

p/n	Description
2500428	External Wi-Fi Antenna Mount Kit

Cover, Outer Control

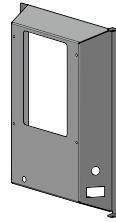

Optional outer control cover is pre-drilled for Outdoor Wi-Fi Module Kit (p/n 2500070).

p/n	Description
2000320	Outer Control Cover

Water Temperature Indicator Kit, Indoor

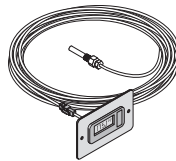

Remote inline monitoring of water temperature (battery operated). Includes LCD, 75 feet of cord and probe. Dip switch can be set to either Fahrenheit or Celsius. NOTE: Black Tee (p/n 133) and Hex Bushing (p/n 180) are not included with the kit.

Replacement battery is AG13 alkaline button cell.

p/n	Description
5052	Indoor Water Temperature Indicator Kit
133	Tee, Black, 3/4" NPT
180	Hex Bushing, 3/4" x 1/8"

24 Fan Conversion Kit - Classic Edge/Classic Edge HD

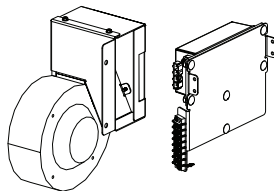

Kit is used to allow a Classic Edge or Classic Edge HD furnace to be operated with 24V DC (for systems off the grid, for example). Includes a 24V Combustion Fan and a low-voltage replacement power supply. Only for Classic Edge or Classic Edge HD 350, 550 or 750 models.

p/n	Description
2500398	24V Fan Conversion Kit

24V Fan Conversion Kit - Classic Edge HDX

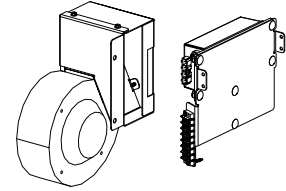

Kit is used to allow a Classic Edge HDX furnace to be operated with 24V DC (for systems off the grid, for example). Includes a 24V Combustion Fan and a low-voltage replacement power supply. Only for Classic Edge HDX 360, 560 or 760 (will not work for Classic Edge HDX 960).

p/n	Description
2500633	24V Fan Conversion Kit

Grounding Rod Kit

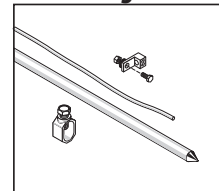

Used to electrically ground the furnace.

p/n	Description
6593	Grounding Rod Kit

LED Light Kit - Classic Edge

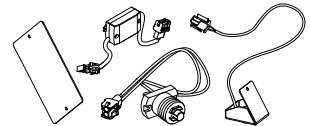

Adds an LED light under the eave on the controller side of the furnace.

p/n	Description
2500144	LED Light Kit

LED Light Kit, Secondary - Classic Edge

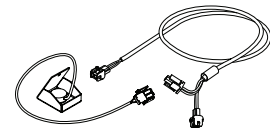

Secondary LED light is installed under the eave on the side of the furnace opposite the controller.

NOTE: Requires LED Light Kit (p/n 2500144).

p/n	Description
2500145	Secondary LED Light Kit

Outdoor Furnace Products

OPTIONS & ACCESSORIES

Bypass Alarm Kit - Classic Edge 750

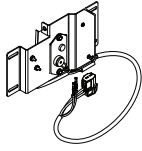

Adds a bypass alarm on Classic Edge 750 models. The bypass alarm sounds to let the operator know the bypass door is open.

p/n	Description
2500153	Bypass Alarm Kit, Classic Edge 750

Hopper Extension Kit - Maxim

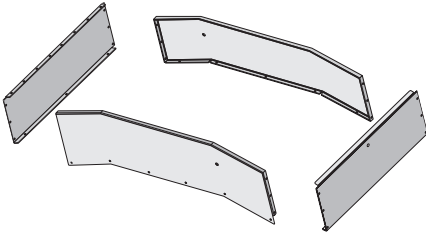

Increases hopper capacity by 3 bushels. For M175 models only.

p/n	Description
4536	Hopper Extension Kit - Green
4537	Hopper Extension Kit - Terra Brown

Hopper, 48-Bushel Kit - Maxim

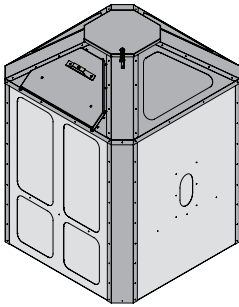

Increases fuel storage capacity, for all Maxim models. Does not include auxiliary auger. Use the 5-1/2' Auxiliary Auger Kit (p/n 2500007) to locate the 48-Bushel Hopper to the side of the outdoor furnace. Available in either green and olive gray or terra brown and taupe to match the Maxim. Dimensions: 48" x 48" x 66".

p/n	Description
9760	48-Bushel Hopper Kit - Green and Olive Gray
9660	48-Bushel Hopper Kit - Terra Brown and Taupe

Auxiliary Auger Kits - Maxim

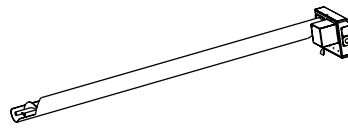

Transfer augers for external hoppers. Use 5-1/2' Auxiliary Auger Kit (p/n 2500007) with the 48-Bushel Hopper Kit (p/n 9660 or 9760) when the hopper is located to the side of the furnace. The 6' Auxiliary Auger Kit (p/n 2500008) and 8' Auxiliary Auger Kit (p/n 2500009) will not work with the 48-Bushel Hopper.

NOTE: For furnaces with a serial number prior to M16073, the Power Cord (p/n 4177) must be purchased separately.

p/n	Description
2500008	Auxiliary Auger Kit, 6'
2500007	Auxiliary Auger Kit, 5-1/2'
2500009	Auxiliary Auger Kit, 8'
2000041	Replacement Gear Motor, Auxiliary Auger
4177	Power Cord (see note above)

Bag Holder Kit - Maxim

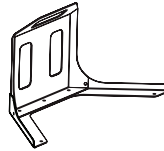

Bag Holder attaches to the inside of the door of the 48-Bushel Hopper to support bag of fuel.

p/n	Description
9804	Bag Holder Kit

Hopper Vibrator Kit - Maxim

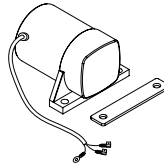

Vibrator attaches to the side of the Maxim's integrated hopper to keep fuel from bridging. Templates provided for both M175 or M250/M255 P models.

p/n	Description
9691	Hopper Vibrator Kit

Auxiliary Auger Vibrator w/Timer Kit - Maxim

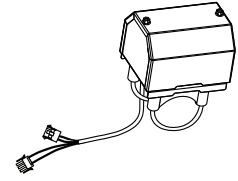

Vibrator is installed on the auxiliary auger connected to an external 43-bushel or 48-bushel hopper. For use with Auxiliary Auger Kits 2500007, 2500008 and 2500009 only. Vibration occurs based on timer setting.

p/n	Description
9458	Auxiliary Auger Vibrator w/Timer Kit

Corn Aerator Kit - Maxim

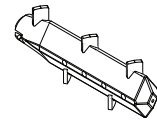

Aerator is designed to optimize operation (for M250, M255 P and M255 PE models only) when burning corn. Paddles on the aerator are wear items; kit includes two additional paddles.

p/n	Description
2500358	Corn Aerator Kit

Corn Aerator Paddle Kit - Maxim

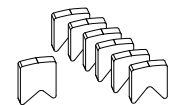

Kit for adding paddles to aerator for burning corn. Kit requires welding paddles to existing aerator. Paddles on the aerator are wear items; kit includes two additional paddles. For M250, M255 P and M255 PE models only.

p/n	Description
2500359	Corn Aerator Paddle Kit

Outdoor Furnace Products

OPTIONS & ACCESSORIES

Transfer Auger with Fuel Door Assembly Kit - M175

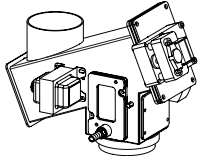

Kit includes transfer auger assembly with fuel door to reduce pellet consumption in low mode, allow the furnace to operate more efficiently and help prevent the condition in which the water suppression valve opens.

p/n	Description
2500073	Transfer Auger with Fuel Door Assembly Kit - M175

Hopper Kit with Fuel Door - M250/M255 P

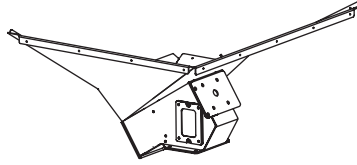

Kit includes hopper assembly with fuel door to reduce pellet consumption in low mode, allow the furnace to operate more efficiently and help prevent the condition in which the water suppression valve opens.

p/n	Description
2500050	Hopper Assembly with Fuel Door Kit - M250/M255 P

Clean Out Kit, Battery - Maxim

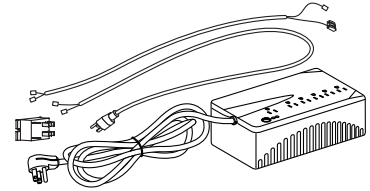

Provides power to clean out the burner auger in the event of a back burn condition during a power failure. Kit includes UPS, wiring, relay and brackets for M175 and M250/M255 P.

NOTE: Not for use with Maxim M255 PE models.

p/n	Description
2500005	Battery Clean Out Kit
2500143	Backup Battery Replacement

Outdoor Furnace Products

WATER TREATMENT / FIREBOX PROTECTION

MolyArmor 350 Corrosion Inhibitor



MolyArmor 350 Corrosion Inhibitor provides excellent water jacket corrosion protection when properly maintained at a minimum of 350 ppm. It is easy to test for maintenance levels with a test kit (p/n 2500598). One gallon of MolyArmor 350 Corrosion Inhibitor treats 200 gallons of system water.

Models	Initial MolyArmor 350 Amount
Maxim M255 PE	1/2 gal.
Classic Edge 360, 560, CL 4030, 5036	1 gal.
Forge 1500	1-1/2 gal.
Classic Edge 760, CL 6048, ECL 3250,	
Forge 3500	2 gal.
Classic Edge 960, Pallet Burner	3 gal.
CL 7260	4 gal.

p/n	Description
2900630	MolyArmor 350 Corrosion Inhibitor

Sludge Conditioner



Reduces mineral deposits in boiler side of water-to-water heat exchangers. Can be used as a preventative when filling the furnace or as a rescue treatment if corrosion occurs in the water jacket due to improperly maintained Corrosion Inhibitor levels.

Refer to following chart for the amount to use for each model furnace for preventative or rescue treatment applications. Note that 1 unit = 1 gallon.

PREVENTATIVE IN HARD WATER: While it is best to use softened water when filling the furnace, Sludge Conditioner should be used if the water quality is known to contain higher concentrations of minerals or solids.

RESCUE TREATMENT FOR CORROSION: If a furnace has been subjected to low Corrosion Inhibitor levels and corrosion is evident in the water jacket, Sludge Conditioner can be used by circulating through the furnace for one week to help clean some of the corrosion from inside the water jacket before flushing and refilling.

Models	Preventative Amount	Rescue Amount
Classic Edge 350/360		
CL 4030, Forge 1500	1/2 unit	1 unit
Classic Edge 550/560, 750/760		
E-Classic 1400, 1450, 2300, 2400		
CL 5036, CL 6048, Forge 3500	1 unit	2 units
Classic Edge 960, E-Classic 3200, 3250		
CL 7260, Pallet Burner	2 units	4 units

p/n	Description
166	Sludge Conditioner, 1 gal.

Moly/pH Test Kit



Test Kit for testing your furnace water pH and Moly. Only requires a single strip for testing both pH and Moly. 25 test strips included; instructions are provided on the kit bottle.

p/n	Description
2500691	Moly/pH Test Kit, Complete

Ashtrol



Used as a furnace firebox pH modifier.

p/n	Description
297	Ashtrol, 6.25 lbs

Water Sample Bottle Kit



Used to submit required water samples for Titanium model furnaces. Each kit includes two bottles, two shipping boxes, and two generic mailing labels. Includes instructions.

p/n	Description
2500415	Kit, Water Sample Bottle

Cartridge, Water Softener



For single use in filling water jacket, Water Softener Cartridge has 5,000 grains of removal capacity. For average water with 10 grains hardness, will treat 500 gallons water. May also be connected together to increase removal capacity.

p/n	Description
1310	Water Softener Cartridge

Water Test Kit



Water Test Kits and replacement items for testing your furnace water ONLY if treated with 1650XL and MolyBoost. Complete kits include pH test strips.

p/n	Description
598	Water Test Kit, Complete
2900617	Ferroun Indicator
2900618	CAN Solution
153	Litmus Paper

Sediment Trapper Filter, Hot Water, 3/4"

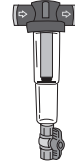

Centrifugal separation technology and 100 mesh filter element. Amber see-through cover easily removeable for cleaning using no tools. Bottom valve used to empty sediment. Stainless steel screen filter is cleanable and reusable.

Rated to 200°F (93°C) @ 40 psi. Dimensions: 14-3/8" L x 5" W. Port size: 3/4" FPT.

p/n	Description
2900578	Hot Water Sediment Trapper Filter, 3/4" FPT
5000683	O-Ring, Replacement, for Hot Water Filter (p/n 2900578)

Outdoor Furnace Products

TOOLS

PEX Pipe Cutter

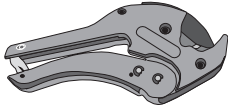

Designed for smooth, even cutting, the tool's jaw fits firmly over the pipe for a square, burr-free cut.

p/n	Description
2900619	PEX Pipe Cutter

Cinch Tool

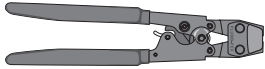

Tool for cinching 1" and 1/2" PEX Stainless Steel Clamp Crimp Rings to PEX pipe. Not for use with any other application.

p/n	Description
5925	Cinch Tool

Ratchet Cinch Tool

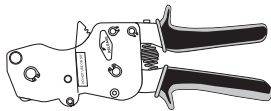

Compact, easy-to-use Ratchet Cinch Tool comes with calibrating device. For use with 5927, 5926 and 5000465 crimp rings.

p/n	Description
4472	Ratchet Cinch Tool

Clamp Crimp Ring Removal Tool

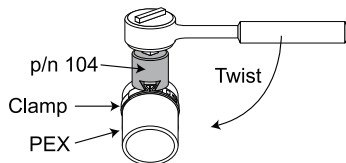

Used to remove PEX stainless steel clamp crimp rings (p/n 5927 and 5926).

p/n	Description
104	Clamp Crimp Ring Removal Tool

PEX Piping Clip Gun

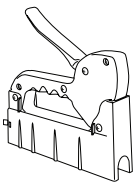

Used to secure 1/2" PEX pipe. Clips sold separately.

p/n	Description
2900002	PEX Piping Clip Gun

Decoiler

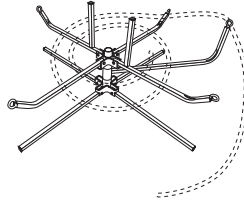

Useful when uncoiling and installing 1/2" tubing.

p/n	Description
1323	Decoiler

Plug, Pipe - Wrench Set

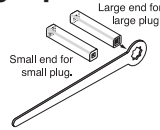

Large end is for 1-1/4"; small end fits 3/4" pipe plugs.

p/n	Description
5459	Pipe Plug Wrench Set

Fin Comb

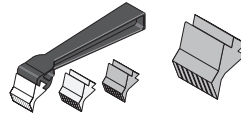

Tool with six interchangeable heads for straightening fins on water-to-air heat exchangers. For all units with 8, 9, 10, 11, 12 and 14 fins per inch.

p/n	Description
5918	Fin Comb

Torch, Outdoor

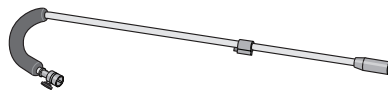

Torch design allows easy starting of the fire in Classic Edge, E-Classic and Maxim models.

p/n	Description
2900325	Outdoor Torch

Wood Moisture Meter Kit

Kit includes wood moisture meter, carrying case, remote probe, replacement contact pins, protective cover for remote probe pin, owner's manual and quick reference guide.

p/n	Description
8656	Wood Moisture Meter Kit

Wood Moisture Meter, Mini 3-in-1



Measures accurately the moisture level of wood with a range of 6% - 42%, and the ambient temperature (°C/°F). Mini in size and portable for field works, very easy to operate and delivers accurate readings instantly.

p/n	Description
2900393	Wood Moisture Meter, Mini 3-in-1

Multimeter, Digital Pocket



Digital multimeter performs several electrical measurement functions in one simple-to-use instrument.

p/n	Description
2657	Digital Pocket Multimeter

Crimp Tool, Universal

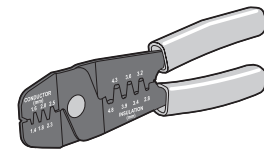

Used to crimp terminals. For 14-24 AWG wires.

p/n	Description
2900341	Universal Crimp Tool, 14-24 AWG

Pin Extraction Tool

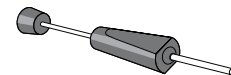

Tool for removing contact pins from behind connector blocks on E-Classic models.

p/n	Description
2656	Pin Extraction Tool

Outdoor Furnace Products

TOOLS

Chimney Cleaning Kit - 6"

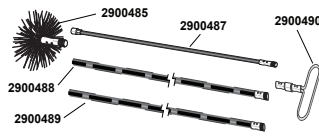

Kit for cleaning both the horizontal and vertical portions of all 6" chimneys. Replacement components may be purchased individually.

p/n	Description
2500296	Chimney Cleaning Kit, 6"
2900485	6" Chimney Brush
2900487	Extension Rod, 48" Fiber
2900488	Extension Rod, 48" Wire
2900489	Extension Rod, 72" Wire
2900490	Handle

Chimney Cleaning Kit - 8"

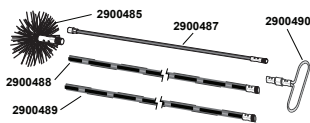

Kit for cleaning both the horizontal and vertical portions of all 8" chimneys. Replacement components may be purchased individually.

p/n	Description
2500297	Chimney Cleaning Kit, 8"
2900486	8" Chimney Brush
2900487	Extension Rod, 48" Fiber
2900488	Extension Rod, 48" Wire
2900489	Extension Rod, 72" Wire
2900490	Handle

Cleaning Tool, Afterburner

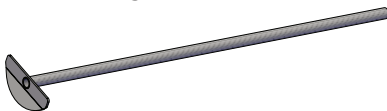

Tool for cleaning Afterburner and Reaction Chamber on Classic Edge HDX models.

p/n	Description
1200897-011	Afterburner Cleaning Tool

Cleaning Tool, Heat Exchanger



Tool for cleaning multiple areas on Classic Edge models.

p/n	Description
3105186-011	Heat Exchanger Cleaning Tool

Ash Shovel, Reaction Chamber

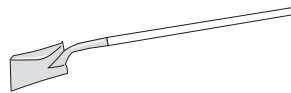

Flat shovel is used to remove ash. The shovel head angle allows for cleaning to the back of the Reaction Chamber on E-Classic and Classic Edge models.

p/n	Description
2900535	Ash Shovel

Ash Shovel - E-Classic

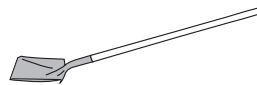

Used to remove ash from E-Classic models.

p/n	Description
1970	Ash Shovel

Ash Shovel - Classic

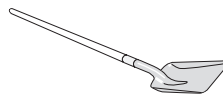

Used for removing ash from Classic models.

p/n	Description
299	Ash Shovel

Ash Rake - Classic



Long, metal-handled ash rake is used to pull coals forward and to stir ashes in Classic models.

p/n	Description
300	Ash Rake

Scraper Tool

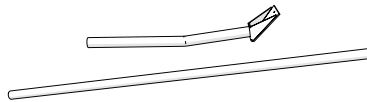

Used to maintain and clean the firebox.

p/n	Description
2900534	Scraper Tool

Hoe, Firebox - Classic

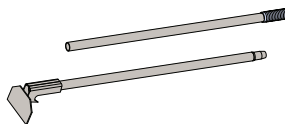

Used as a firebox maintenance tool for Classic models; hoe comes with metal handle.

p/n	Description
2900001	Hoe, Firebox, 72"

Flue Brush & Handle

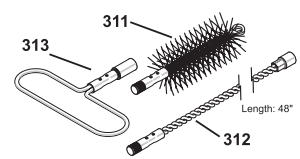

Used to clean the flue passageways of E-Classic 2300 and M175 models. Flue Brush Kit (p/n 310) includes 311, 312 and handle. Not to be used for cleaning 6" or 8" chimney.

p/n	Description
310	Flue Brush Kit
311	Flue Brush Only
312	Extension Rod, 48"
313	Replacement Handle

Flue Brush & Handle Kit



Used to clean the flue passageways of E-Classic 2400 models and of Maxim M250/M255 P models. Flue Brush Kit (p/n 390) includes 398, 312 and handle. Not to be used for cleaning 6" or 8" chimney.

p/n	Description
390	Flue Brush Kit

Scraper, Heat Exchanger - E-Classic



Used to clean the flue passageways of E-Classic models.

p/n	Description
2000128	Heat Exchanger Scraper, E-Classic 3200
2000127	Heat Exchanger Scraper, E-Classic 1450

Cleaning Rod - Classic Edge / E-Classic



Used to clean the firebox.

p/n	Description
2001235	Cleaning Rod, Tempered, 5/8"

Cleaning Rod - Maxim



Used to clean the firebox.

p/n	Description
317	Cleaning Rod

Integrated Cleaning System - Classic Edge

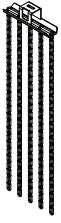

Installed in the heat exchanger and used with Cleaning Rod (p/n 9439) to clean heat exchanger in Classic Edge models without rear cleanout door.

p/n	Description
2500374	Integrated Cleaning System, Classic Edge 350/550
2500375	Integrated Cleaning System, Classic Edge 750

Cleaning Rod Scraper Attachment - Classic Edge / E-Classic

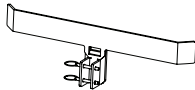

Attaches to the Cleaning Rod (p/n 9439) for cleaning the refractory slot.

p/n	Description
2500198	Cleaning Rod Scraper Attachment

Ash Scoop - Maxim



4-Quart galvanized Ash Scoop is ideal for cleaning ashes from furnace.

p/n	Description
315	Ash Scoop

Solder & Soldering Flux



Low melting-point solder for easier soldering. Soldering flux includes brush. Use for easier soldering of copper sweat fittings.

p/n	Description
1325	Solder
100	Soldering Flux (6 oz)

Brush, Cleaning



For cleaning the inside of copper fittings.

p/n	Description
378	Cleaning Brush, 3/4"
379	Cleaning Brush, 1"

Clamp, Rubber

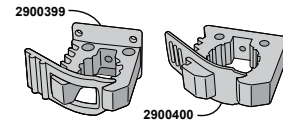

Accessory for holding cleaning tools. Available in two sizes. Price is for one clamp. Mounts with bolts or screws (not included).

p/n	Description
2900399	Rubber Clamp, Quick Fist, 0.63"-1.38"
2900400	Rubber Clamp, Quick Fist, 1.00"-2.25"

Outdoor Furnace Products

DOOR & RELATED

Draft Inducer

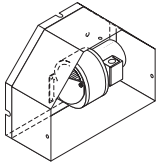

Bolts to existing draft hood (fan included). Must use 5-A fuse. Do not use CL 7260 High-Output fan (p/n 5549 or 2500640) if a burner has been installed on the outdoor furnace. The 203 Blower & Motor, 1/15-hp can be used if a fan only is needed for the high output draft inducer (p/n 5549 or 2500640). Draft Inducer (p/n 700) - 180 cfm; Draft Inducer (5549 and 2500640) - 450 cfm.

Draft inducer applications:

- Side Draft (p/n 400) - up to s/n 13427
- Ripple Front Door (p/n 500) - s/n 13428 to s/n 19125
- Flat Front Cast Door (p/n 700) - s/n 19126 and later; non-Titanium models 4030 (s/n CL401000-CL401039), 5036 (s/n CL501000-CL501229), 6048 (s/n CL601000-CL601231); not for use with Titanium models
- Flat Front Steel Door (p/n 2500390)
- Draft Inducer for non-European Pallet Burner firebox door (p/n 5247) includes fan; does NOT include fuses. Side Draft Inducer for Pallet Burner (p/n 9623) includes fan

p/n	Description
400	Draft Inducer, Side Draft
500	Draft Inducer, Ripple Front Door

NOTE: If the outdoor furnace does not have an inner shield on the inside of the draft opening, it will be necessary to install Inner Shield Kit (p/n 553) before installing the Draft Inducer Kit (p/n 500).

p/n	Description
553	Inner Shield Kit
700	Draft Inducer, Flat Front Door

CL 4030 / 5036 / 6048

p/n	Description
2500390	Draft Inducer, Flat Front Steel Door, CL 4030, 5036, 6048

CL 7260

p/n	Description
6576	Draft Inducer, CL 7260 Dual Fuel (w/fuses)
5549	Draft Inducer, Cast Door, CL 7260 High Output
2001046	Draft Inducer, Steel Door, CL 7260
2500640	Draft Inducer, Steel Door, CL 7260 High Output

203	Replacement fan for High Output Draft Inducer (p/n 5549, 2500640) only
-----	--

Pallet Burner

p/n	Description
2001050	Draft Inducer, Steel Door, Pallet Burner
5247	Draft Inducer, Pallet Burner firebox door
9623	Side Draft Inducer, Pallet Burner

Draft Inducer Replacement Fan applications:

- **Combustion Fan (p/n 5009)** - Replacement combustion fan without connectors for Draft Inducer kit# 500. For furnace models with recessed cast doors only.
- **Combustion Fan (p/n 11606)** - Replacement combustion fan with wiring for Classic/Pallet Burner cast door draft inducer kits 700, 6494, 6576, 5247 and Classic/Pallet Burner steel door draft inducer kits 2500390, 2001046, 2001050.
- **Combustion Fan (p/n 11618)** - Replacement combustion fan for Draft Inducer kit# 5549 or 2500640.
- **Combustion Fan (p/n 2000737)** - Replacement combustion fan for draft inducer kits 400 and 9623.

NOTE: On E-Classic 2300 models with s/n E17807 and earlier, connector will need to be removed.

p/n	Description
5009	Combustion Fan w/out Connectors
11606	Combustion Fan w/Wiring
11618	Combustion Fan
2000737	Combustion Fan Assembly

Door Seal Kits - Classic Edge/E-Classic

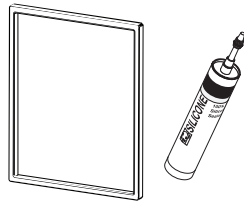

Door Seal Kits include silicone-coated fiberglass door seal, black silicone and instructions.

p/n	Description
2500641	Door Seal Kit - Classic Edge 350/360
2500642	Door Seal Kit - Classic Edge 550/560
2500643	Door Seal Kit - Classic Edge 750/760
2500644	Door Seal Kit - Classic Edge 960
2500644	Door Seal Kit - E-Classic 2300, 2400/3200/3250
2500642	Door Seal Kit - E-Classic 1400/1450
4050036	Foam Bumper Pad, Door Switch - Classic Edge and Forge models
806	Black Silicone

Door Seal, Silicone-Coated, 100-ft

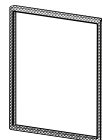

Silicone-coated 7/8" Door Seal is available in 100-foot lengths.

p/n	Description
6000064	Door Seal, Silicone-Coated, 7/8", 100-ft

Door Seal Kits - Classic/Pallet Burner

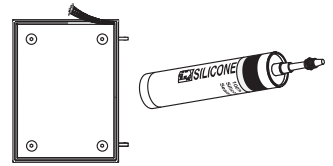

Kit includes Door Seal Rope cut to length and Black Silicone Adhesive.

p/n	Description
363	Door Seal Kit - Classic Models (except CL 7260), Forge models
364	Door Seal Kit - CL 7260
365	Door Seal Kit - Pallet Burner

Rope, Door Seal

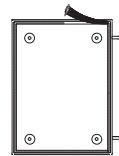

Sold either by the foot or in pre-cut lengths for specific model applications. Silicone is not included.

NOTE: For CL 4030 and 5036 models, Door Seal Rope (p/n 360) should be cut to 8 feet before installing.

p/n	Description
7674	Rope, 7/8", per ft
7594	Door Seal Rope, 1", per ft
360	Door Seal Rope, 7/8", 9' for CL 4030, 5036, 6048, Forge models
361	Door Seal Rope, 1", 12' for CL 7260
367	Door Seal Rope, 1", 23' for Pallet Burner

Rope, Door Seal and Chimney Transition Box Cover - Maxim

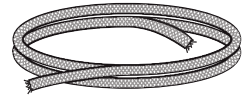

Rope may be used for door seal or chimney transition box cover seal (each requires a 5-ft section). Sold by the foot. Silicone is not included.

p/n	Description
809	Door Seal Rope, 3/4", per ft

Outdoor Furnace Products

DOOR & RELATED

Linkage

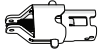

Linkage between the solenoid and damper control. Each linkage comes complete with cotter pins.

p/n	Description
2500053	Spring-Assisted Linkage, All Linkage Models
6145	Spring, Replacement for 2500053

Hinge, Rear Door - Kit

Replacement hinge kit for rear door.

p/n	Description
2500045	Rear Door Hinge Kit - E-Classic 1450/3200

Solenoid

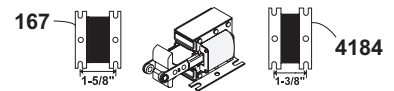

Because damper control solenoids are not interchangeable, check measurement and application dates carefully. Solenoid (p/n 167) is for pre-June 2000 Classic models. Solenoid (p/n 4184) is for models after June 2000 including all E-Classic models.

p/n	Description
167	Solenoid, 1-5/8" center-to-center bracket hole
4184	Solenoid, 1-3/8" center-to-center bracket hole

Outdoor Furnace Products

GAS RELATED

Dual Fuel Burner Kits and Components

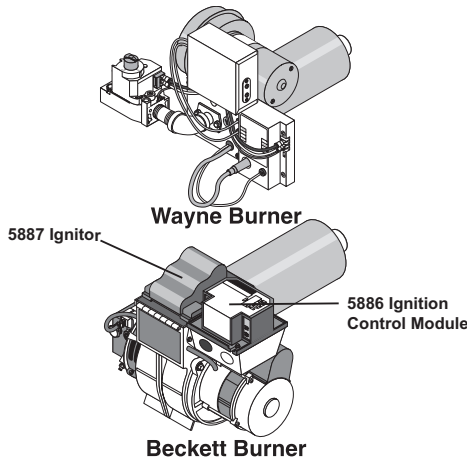

Gun-type burners are set up to Central Boiler's specifications. Kits include everything needed to mount the burner on the furnace.

Dual Fuel Kits

These kits are for Classic outdoor wood furnace models with a serial number after 35515 and Hydofire models after HF101414. For models prior to these serial numbers, refer to the Retro Dual Fuel Kits below for the proper application.

p/n	Description
6834	Beckett Burner Kit, oil*
6844	Beckett Burner Kit, oil**
6833	Wayne Burner Kit, LP*
6843	Wayne Burner Kit, LP**

*For all models except CL 7260 **For CL 7260

Gas Burner Kits - E-Classic

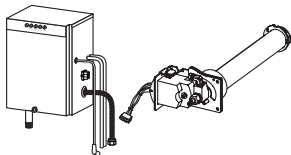

Optional LP gas burner for E-Classic 1400 IR, 1450 IR, 2400 IR and 3200 IR models.

p/n	Description
2500002	LP Gas Burner Kit, E-Classic 1400 IR Models
2500000	LP Gas Burner Kit, E-Classic 1450 IR Models
2500011	LP Upper Burner Kit, E-Classic 2300
2500003	LP Gas Burner Kit, E-Classic 2400 IR Models
2500004	LP Gas Burner Kit, E-Classic 3200 IR Models

Conversion Kit, Natural Gas - E-Classic

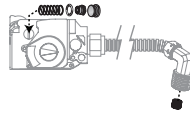

Converts E-Classic IR models with an optional LP gas burner (see E-Classic Gas Burner Kits) from propane to natural gas.

p/n	Description
2500001	Natural Gas Conversion Kit, E-Classic IR Models

Conversion Kit, Natural Gas - E-Classic

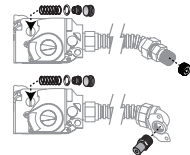

Converts original burners on E-Classic 2300 models from propane to natural gas (will not work with replacement burner kit 2500011).

p/n	Description
10598	Natural Gas Conversion Kit

Conversion Kit, Natural Gas - E-Classic

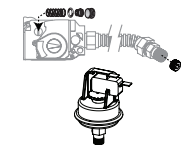

Converts E-Classic 1400 or 2400 models from propane to natural gas.

NOTE: NG Conversion Kit only needed for gas burner kits sold before Dec. 1, 2010. After that date, complete gas burner kits are available.

p/n	Description
10588	Natural Gas Conversion Kit, E-Classic 1400/2400

Gasket, Ignitor Burner

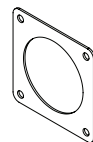

Replacement ignitor burner gasket for E-Classic 2300 models.

p/n	Description
8838	Ignitor Burner Gasket

Regulator Kit, 2-Stage Gas

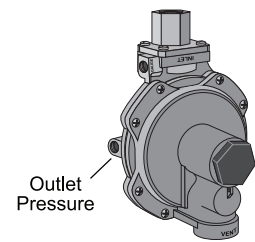

Regulates the gas pressure from an LP tank. For E-Classic and Maxim models.

p/n	Description
1930	2-Stage Gas Regulator Kit

Hose w/Regulator, Propane - Maxim

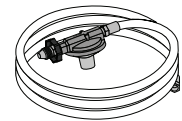

For use with M175 models only. Not recommended for use in cold weather.

p/n	Description
5567	Gas Hose w/Regulator

Shut-off with Level Indicator, Propane - Maxim

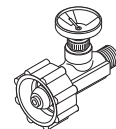

Used to monitor propane in a BBQ-style tank with Type 1 Acme threads connected to a Maxim furnace.

p/n	Description
4220	Propane Shut-off with Level Indicator

Outdoor Furnace Products

CHIMNEY

Chimney Sections, 8" - Classic

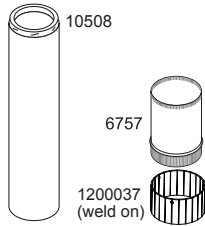

Type HT listed, factory-built, all stainless steel chimney section. If connecting to Chimney Extension (p/n 6500002), use 8" Chimney Band Clamp Kit (p/n 4518) at the joints, not Chimney Snaplock Clamp (p/n 10509). Sections are four feet long. The 8" Chimney Ring (p/n 1200037) is required for Classic furnaces with the square chimney box (requires welding to the furnace).

NOTE: Classic furnaces with a square chimney box require a Chimney Conversion Adapter (p/n 6757).

p/n	Description
10508	8" Chimney Extension, 4'
6757	Chimney Conversion Adapter, 8"
1200037	Chimney Weld Ring, 8"

Chimney Sections, 8" - Classic Edge 750/760/960, E-Classic

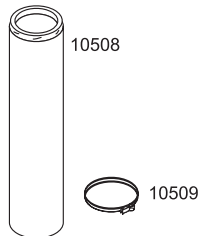

8" Stainless steel chimney currently shipped with Classic Edge 760 and 960 models and E-Classic models (except ECL 1450). Shipped with ECL 1400 since s/n E100299 and E-CL 2300 since s/n E17856. Compatible with Chimney Extension (p/n 6500002). If connecting to Chimney Extension (p/n 6500002), use 8" Chimney Band Clamp Kit (p/n 4518) at the joints, not Chimney Snaplock Clamp (p/n 10509). For outdoor applications only. Not to be used for venting of indoor heating appliances.

p/n	Description
10508	8" Chimney Extension, 4'
10509	Chimney Snaplock Clamp, 8"

Chimney Sections, 6" - Classic Edge 350/360 and 550/560, E-Classic 1450, Forge 1500/3500

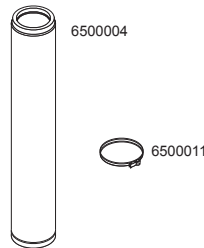

Type HT listed, factory-built, all stainless steel 6" chimney section. Sections are four feet long. Chimney Snaplock Clamp (6500011) should be used at each joint.

p/n	Description
6500004	6" Chimney Extension, 4'
6500011	Chimney Snaplock Clamp, 6"

Chimney Sections, 6" - Maxim

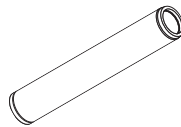

Type HT listed, factory-built, all stainless steel 6" chimney section. Sections are four feet long. Chimney Snaplock Clamp (6500011) should be used at each joint.

p/n	Description
6500004	6" Chimney Extension, 4'
6500011	Chimney Snaplock Clamp, 6"

Chimney Cap/Spark Arrestor

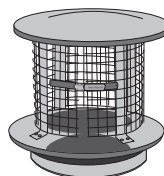

New version chimney cap/spark arrestor provides better fit, features a snaplock clamp and screen that is secured with a clamp-on fastener for easy removal. Available for 6" and 8" chimneys.

p/n	Description
2900597	6" Chimney Cap, Spark Arrestor
2900598	8" Chimney Cap, Spark Arrestor

Chimney Band Clamp Kit, 6"



Reinforces strength between two sections of 6" chimney.

p/n	Description
9535	Chimney Band Clamp Kit, 6"

Chimney Band Clamp Kit, 8"

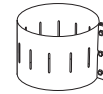

Reinforces strength between two sections of 8" chimney.

p/n	Description
4518	Chimney Band Clamp Kit, 8"

Chimney Attachment Ring

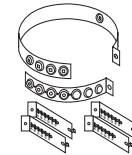

Used with electrical conduit (not included) to reinforce chimney when five or more sections are used. For 6" chimneys, must be located directly below 6" Chimney Locking Band (p/n 6500011) to reduce stress on the joint. For 8" chimneys, must be located directly below 8" Chimney Locking Band (p/n 10509) to reduce stress on the joint.

p/n	Description
774	Chimney Attachment Ring

Chimney Guy-Wire Band, 6"

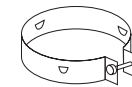

Attached to the outer casing of a 6" chimney to hold three guy-wires (not included). Recommended for chimneys exceeding the roof by 5' to 13' maximum.

p/n	Description
776	Guy-Wire Band

Chimney Guy-Wire Band Kit, 8"



Used to provide additional stability to chimneys in installations where property damage could occur within the fall zone of the chimney. Guy wire is not included in kit.

p/n	Description
778	Chimney Guy-Wire Band Kit

Outdoor Furnace Products

CHIMNEY

Chimney Base Brace Kit, 6"



Used to reinforce the chimney base when three or more chimney sections are used.

p/n	Description
2500044	Chimney Base Brace Kit, 6"

Chimney Base Brace Kit, 8"

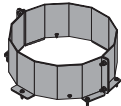

Used to reinforce the chimney base when three or more chimney sections are used.

p/n	Description
4519	Chimney Base Brace Kit, 8"

Chimney Components

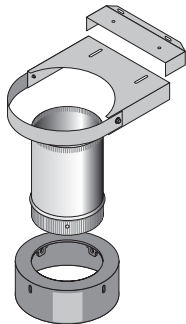

Chimney Adapter Kit (p/n 10895) converts CL 7260 and Pallet Burner models to the 8" Chimney Extension (p/n 10508). The conversion will require three Chimney Extensions (p/n 10508).

Chimney Extension Components	
p/n	Description
10895	Chimney Adapter Kit, 10" to 8", For Pallet Burner and CL 7260 models
6172	Elbow, 8", 45-degree

Chimney Tee Kits, Stainless Steel

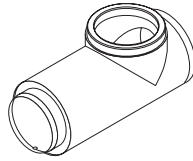

Type HT listed, factory-built, all stainless steel chimney tee. Kit includes chimney tee cover and chimney tee rope rings. NOTE: Silicone (p/n 806) is not included.

10" Chimney Tee Kit (p/n 11605) - Classic CL 7260 and Pallet Burner.

8" Chimney Tee Kit (p/n 2500621) - Classic Edge 750/760/960.

8" Chimney Tee Kit (p/n 2500245) - E-Classic 3200, 3250.

8" Chimney Tee Kit (p/n 2500433) - E-Classic 1400, 2300, 2400, Classic CL 4030, 5036, 6048.

6" Chimney Tee Kit (p/n 2500620) - Classic Edge 350/360, 550/560.

6" Chimney Tee Kit (p/n 2500244) - Forge 1500, 3500.

6" Chimney Tee Kit (p/n 2500416) - E-Classic 1450.

p/n	Description
11605	10" Chimney Tee Kit
2500621	8" Chimney Tee Kit
2500245	8" Chimney Tee Kit
2500433	8" Chimney Tee Kit
2500620	6" Chimney Tee Kit
2500244	6" Chimney Tee Kit
2500416	6" Chimney Tee Kit

Chimney Support Brace Kit

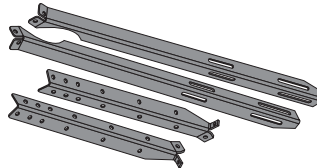

Reinforces strength of chimney support when several chimney sections are used. For use only with CL 4030, CL 5036 and CL 6048 models.

p/n	Description
4554	Chimney Support Brace Kit

Chimney Support Brace Kit

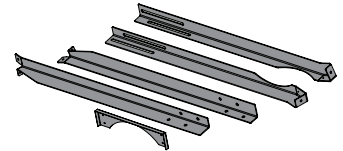

Reinforces strength of chimney support when several chimney sections are used. For use only with CL 7260 and Pallet Burner models.

p/n	Description
8402	Chimney Support Brace Kit

Chimney Tee Restrictor Kit

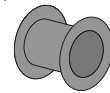

Installed in chimney tee to lower the burn rate. For use only with CL 4030, CL 5036 and CL 6048 models.

p/n	Description
10970	Chimney Tee Restrictor Kit

Chimney Rope Ring

Replacement rope ring for chimneys. See table below for applications. When ordering p/n 809, 7674 or 7594, specify the length in feet.

Model	Rope Ring part number	
	Between chimney connector and furnace	Below first chimney section
ECL 1400	6000033	7632
ECL 1450	6000034	7674 (order 2 ft)
ECL 2300	6000033	7632
ECL 2400	6000033	7632
ECL 3200	6000033	7632
CL 4030	6000033	7632
CL 5036	6000033	7632
CL 6048	6000033	7632
CL 7260	7674 / 7594 (order 3 ft of each)	7632
Classic Edge 750/760/960	6000033	7632
Classic Edge 350/360 550/560	6000034	809 (order 2 ft)
Forge 1500/3500	6000034	809 (order 2 ft)

p/n	Description
6000033	Rope Ring (only), 2" Low Density Braid, 8" I.D.
6000034	Rope Ring (only), 1.75" Low Density Braid, 6" I.D.
7632	Rope Ring, 3/4", 8" ID
809	Door Seal Rope, 3/4", per ft
7674	Rope, 7/8", per foot
7594	Rope, 1", per foot

Door Rope and Seals - Classic Edge

Tables below provides actual length; however, seal must be purchased in lengths of feet. Cutting may be required. When ordering, specify the length in feet.

Airbox Door Seal (p/n 8863)

All Classic Edge x50 Models	
Top/bottom pieces (x2)	19-3/8" (order 2 ft)
Side pieces (x3)	11.5" (order 1 ft)

Airbox Door Seal (p/n 8863)

All Classic Edge HDX Models	
Top/bottom pieces (x2)	12-3/8" (order 2 ft)
Side pieces (x2)	10-3/8" (order 2 ft)

Refractory Rope Seal (p/n 809)

Classic Edge 350/360	37" (order 4 ft)
Classic Edge 550/560	45" (order 4 ft)
Classic Edge 750/760	47" (order 4 ft)
Classic Edge 960	75" (order 7 ft)

Ash Pan Rope Seal (p/n 809)

Classic Edge 350/360	86" (order 8 ft)
Classic Edge 550/560	99" (order 9 ft)
Classic Edge 750/760	115" (order 10 ft)
Classic Edge 960	130" (order 11 ft)

Heat Exchanger Cover Rope Seal (p/n 7674)

Classic Edge 350	60" (order 5 ft)
Classic Edge 550	66" (order 6 ft)
Classic Edge 750	76" per cover (2 covers) - (order 14 ft)

NOTE: Apply 8869 Silicone Adhesive when installing

Rear Cleanout Door Rope Seal (p/n 7674)

Classic Edge 350/360	80" (order 7 ft)
Classic Edge 550/560	88" (order 8 ft)
Classic Edge 750/760	110" (order 10 ft)
Classic Edge 960	110" (order 10 ft)

Reaction Chamber Door Rope Seal (p/n 7674)

Classic Edge 350/360	54" (order 5 ft)
Classic Edge 550/560	54" (order 5 ft)
Classic Edge 750/760	63" (order 6 ft)
Classic Edge 960	70" (order 6 ft)

p/n	Description
809	Door Seal Rope, 3/4", per ft
7674	Door Seal Rope, 7/8", per ft
8863	Seal, 3/16" x 3/4", per ft
8869	Bronze Silicone Adhesive

Door Seals - Forge

Seal must be purchased in lengths of feet. Cutting may be required. When ordering, specify the length in feet.

Airbox Door Seal (p/n 8863)

All Forge Models	
Top/bottom pieces (x4)	10" (order 1 ft)
Side pieces (x4)	8.5" (order 1 ft)

Ash Cleanout Door Rope Seal (p/n 7674)

Forge 1500 / 3500	63" (order 6 ft)
-------------------	------------------

p/n	Description
7674	Door Seal Rope, 7/8", per ft
8863	Seal, 3/16" x 3/4", per ft

NOTES

Numerical Parts List

100	Soldering Flux (6 oz)	29	303	Air Handler Cabinet, 185k-220k Btu, front access	7
102	Heat Exchanger Coil, 95k Btu	5	306	Radiant Mixing Valve, 1/2" NPT fittings	21
103	Street Elbow, 1"	18	310	Flue Brush Kit	28
104	Clamp Crimp Ring Removal Tool	27	311	Flue Brush Only	28
105	Hex Bushing, 1-1/2" x 3/4"	17	312	Extension Rod, 48"	28
106	Heat Exchanger Coil, 100k Btu	5, 6	313	Replacement Handle	28
107	Heat Exchanger Coil, 125k Btu, straight outlets	5	314	Nipple, 1-1/2" x close, Schedule 80, extra heavy	17
108	Heat Exchanger Coil, 140k Btu	5, 7	315	Ash Scoop	29
109	Heat Exchanger Coil, 80k Btu	5	317	Cleaning Rod	28
110	Heat Exchanger Coil, 185k Btu	5	321	Space Heater Cabinet	7
111	Heat Exchanger Coil, 220k Btu	5, 6	322	Fan	6
112	Vent Elbow, 1" x 1" sweat fittings	18	323	Transition	6
113	Replacement Head	20	325	Hex Bushing, 3/4" x 1/2"	17
116	Male Adapter, 3/4" sweat x 3/4" MIP fittings	18	327	Radiant Mixing Valve, 3/4" NPT fittings	21
117	Female Adapter, 3/4" sweat x 3/4" FIP fittings	18	329	Radiant Mixing Valve, 1" NPT fittings	21
118	Nipple, 3/4" x close, Schedule 80, extra heavy	17	330	3-Way Valve, Brass 3/4" FIP	20
119	Pump Flange Kit, 3/4"	14	331	Pipe Plug, 3/4"	17
120	Male Adapter, 1" sweat x 1" MPT fittings	18	332	3/4" Round Pipe Cap	17
123	90° Reducing Elbow, Copper Pipe, 1" x 3/4" sweat fittings	18	333	1-1/4" Round Pipe Cap	17
124	45° Street Elbow, 3/4"	17	340	Relay	6
126	90° Street Elbow, Brass, 3/4"	17	342	Switch, ON/OFF	6
133	Tee, Black, 3/4" NPT	17, 23	353	Louvers, fit Heat Exchanger Coil (p/n 111)	6
138	Tee, Copper Pipe, 1" x 1" x 1" sweat fittings	18	354	Louvers, fit Heat Exchanger Coil (p/n 108)	6
140	Tempering Valve, 3/4" sweat fittings	21	355	Louvers, fit Heat Exchanger Coil (p/n 106)	6
145	Crimp Ring Tool, 1"	12	360	Door Seal Rope, 7/8", 9' for CL 4030, 5036, 6048, Forge models	30
146	Copper Coupling, 3/4" sweat x 3/4" sweat fittings	18	361	Door Seal Rope, 1", 12' for CL 7260	30
147	Copper Coupling, 1" sweat x 1" sweat fittings	18	363	Door Seal Kit - Classic Models (except CL 7260), Forge models	30
153	Litmus Paper	26	364	Door Seal Kit - CL 7260	30
154	Blower & Motor, 1/4-hp 3-speed fan	6, 7	365	Door Seal Kit - Pallet Burner	30
164	Female Adapter, 1" sweat x 3/4" FIP fittings	18	367	Door Seal Rope, 1", 23' for Pallet Burner	30
166	Sludge Conditioner, 1 gal.	26	368	Plug-in Thermostat	22
167	Solenoid, 1-5/8" center-to-center bracket hole	31	372	Vent Elbow, 3/4" x 3/4" sweat fittings	18
169	Adjustable Aquastat with Well, 1/2" MPT	22	376	Copper End Cap, 1" sweat fitting	15, 18
174	Temp. Gauge, 1/2" MPT	15	378	Cleaning Brush, 3/4"	29
175	Taco 006 Bronze Pump	13	379	Cleaning Brush, 1"	29
178	Reducing Tee, 1-1/2" x 1" x 1" sweat fittings	18	380	Male Adapter, 1-1/4" barb x 1-1/4" MIP	16
180	Hex Bushing, 3/4" x 1/8"	17, 23	381	Brass Coupling, 1-1/4" barb x 1-1/4" barb	11, 16
182	Baseboard Corner, Inside	10	382	Brass Elbow, 1-1/4" barb x 1-1/4" barb	16
183	Baseboard Corner, Outside	10	383	Pipe Plug, 1-1/4"	17
186	Ball Valve, 1/2"	20	385	Brass Hex Bushing, 1-1/2" x 3/4"	17
188	24-Volt Transformer	22	386	PEX 1-1/4" Pipe, 328'	11
191	Pool Aquastat, 1/2" NPT fitting	22	388	Hex Bushing, 1-1/4" x 3/4"	17
194	Pump Flange Kit, 1"	14	390	Flue Brush Kit	28
198	Ball Valve, 3/4" Full Port - Lead Free	20	395-011	Manifold	15
199	Brass Hose Bib, 3/4" MPT	20	399	Fixed Aquastat, 190°F	22
200	Sweat Ball Valve, 3/4" x 3/4" sweat fitting - Lead Free	20	400	Draft Inducer, Side Draft	30
203	Blower & Motor, 1/15-hp	7, 30	408	Hex Bushing, 1-1/2" x 1-1/4"	17
204	Adjustable Aquastat	22	409	Nipple, 1-1/4" x close, Schedule 80, extra heavy	17
208	Blower & Motor, 1-hp, 3-speed fan	7	410	Ball Valve, 1-1/4"	20
210	Fan/Motor Assembly for 6773	7	411	90° Street Elbow, 1-1/4"	17
211	Fan/Motor Assembly for 6771	7	412	Hex Bushing, 1-1/4" x 1/2"	17
222	Replacement Cartridge, 006 Series Pumps	13	415	Transition	7
224	"Free Floating" Flange Kit, 3/4"	14	416	Transition	6
225	Isolation Flange Kit, 1-1/4"	14	418	Tee, Black, 1-1/4" NPT	17
226	Isolation Flange with Drain Valve, 3/4"	14	500	Draft Inducer, Ripple Front Door	30
230	Baseboard Joiner	10	515	Fan Center Relay	22
231	Reducer, Copper Pipe, 1" x 3/4" sweat fittings	18	533	Nipple, 3/4" x 2"	17
232	Baseboard End Cap, Left	10	534	Nipple, 3/4" x 7"	17
233	Baseboard End Cap, Right	10	535	Nipple, Brass, 3/4" x 2"	17
234	Baseboard, Complete, 2'	10	536	Nipple, Brass, 3/4" x 7"	17
235	Baseboard, Complete, 3'	10	542	O-Ring Set	14
236	Baseboard, Complete, 4'	10	553	Inner Shield Kit	30
237	Baseboard, Complete, 5'	10	555	Power Supply Cord, 48"	14
238	Baseboard, Complete, 6'	10	556	Power Supply Cord, 32"	14
255	Tee, Copper Pipe, 3/4" x 3/4" x 3/4" sweat fittings	18	573	Y-Strainer, 1" Brass	8
274	90° Street Elbow, 3/4"	17	574	Pipe Plug, Brass 3/4"	17
276	90° Elbow, Copper Pipe, 3/4" x 3/4" sweat fittings	18	587	Multi-stage 24-Volt Thermostat	22
277	90° Elbow, Copper Pipe, 1" x 1" sweat fittings	18	588	Programmable 24-Volt Thermostat	6, 22
286	Automatic Vent Valve	20	598	Water Test Kit, Complete	26
287	Heat Exchanger Coil, 50k Btu	5	603	Panel Radiator, 55-1/4" x 24"	10
290	Fixed Aquastat, 175°F	22	604	TRV II Valve Body and Head, 1/2" Vertical	10
293	PEX Hanger, 1/2"	12	605	LKD Valve Body with No Cap, 1/2" Preset Flow Rate	10
295	PEX Hanger, 1"	12	606	Push-fit Coupling, Straight, 1/2" x 1/2"	19
296	Brass Swing Check Valve, 3/4"	20	607	Push-fit Coupling, Straight, 3/4" x 3/4"	19
297	Ashtray, 6.25 lbs	26	608	Push-fit Coupling, Straight, 1" x 1"	19
299	Ash Shovel	28	609	Push-fit Coupling, Reducing, 1" x 3/4"	19
300	Ash Rake	28	611	Push-fit Female Adapter, 1" x 1" FPT	19
301	Air Handler Cabinet, 100k-140k Btu, front access	7	612	Push-fit Male Adapter, 1" x 3/4" MPT	19

Numerical Parts List

613	Push-fit Elbow, 1" x 1"	19	2657	Digital Pocket Multimeter	27
614	Push-fit Tee, 1" x 1" x 1"	19	2799	ThermoPEX, 1-1/4", 100' Roll	11
615	Push-fit Depth Gauge/Deburring Tool	19	3015	Fan Motor	6
616	Push-fit Disconnect Clip, 1/2"	19	3042	Brass Hex Bushing, 1/2" x 1/8"	17
617	Push-fit Disconnect Clip, 3/4"	19	3822	Kit for 301 - back water access	7
618	Push-fit Disconnect Clip, 1"	19	3825	Kit for 303 - back water access	7
700	Draft Inducer, Flat Front Door	30	3850	Tee, Brass, 3/4" NPT	17
704	Heat Exchanger Coil, 125k Btu, 90° outlets	5	3851	Brass Hex Bushing, 1-1/4" x 3/4"	17
774	Chimney Attachment Ring	33	4177	Power Cord (see note above)	24
776	Guy-Wire Band	33	4184	Solenoid, 1-3/8" center-to-center bracket hole	31
778	Chimney Guy-Wire Band Kit	33	4218	Chimney Support Box Kit - CL 75, CL 7260, Pallet Burner	34
806	Black Silicone	30	4220	Propane Shut-off with Level Indicator	32
809	Door Seal Rope, 3/4", per ft.	30, 34, 35	4472	Ratchet Cinch Tool	27
848	Motor Frame	6	4518	Chimney Band Clamp Kit, 8"	33
849	Transition	6	4519	Chimney Base Brace Kit, 8"	34
851	Fan Blades	6	4536	Hopper Extension Kit - Green	24
956	90° Elbow, 3/4" x 3/4" FPT	6, 17	4537	Hopper Extension Kit - Terra Brown	24
1097	Universal 5x12 Plate Heat Exchanger Mounting Kit	8	4554	Chimney Support Brace Kit	34
1247	Well, 1/2" NPT fitting	22	4928	Brass Adapter, 3/4" female hose x 3/4" male pipe	17
1248	Well, Stainless Steel, 1/2" NPT fitting	22	4929	Brass Adapter, 3/4" male hose x 3/4" male pipe	17
1267	Line Voltage Thermostat	22	5009	Combustion Fan w/out Connectors	30
1280	Fan Motor	6	5052	Indoor Water Temperature Indicator Kit	23
1310	Water Softener Cartridge	26	5247	Draft Inducer, Pallet Burner firebox door	30
1311	Central PEX 1" Pipe, 100'	11	5348	Cap, Brass, 3/4"	20
1312	Central PEX 1" Pipe, 200'	11	5349	Washer, 3/4"	20
1313	Central PEX 1" Pipe, 300'	11	5367	Brass Coupling, 3/4" thread	17
1314	Central PEX 1" Pipe, 500'	11	5459	Pipe Plug Wrench Set	27
1320	Central PEX 1/2" Pipe, 300'	11	5549	Draft Inducer, Cast Door, CL 7260 High Output	30
1321	Central PEX 1/2" Pipe, 500'	11	5567	Gas Hose w/Regulator	32
1322	Central PEX 1/2" Pipe, 1000'	11	5642	Brass Clamp Fittings, 1"	16
1323	Decoiler	27	5643	Brass Clamp Fittings, 1-1/4"	16
1324	PEX Adapter, 1" PEX x 1" MIP fittings	16	5670	PEX 1-1/4" Pipe, 150'	11
1325	Solder	29	5744	Plate Exchanger, 5 x 12-30, 1" Port	8
1329	Manifold w/Valves, 3-Loop	15	5807-011	Plate Mounting Bracket	8
1330	PEX Adapter, 1" PEX x 3/4" MIP fittings	16	5871	Brass Swing Check Valve, 1-1/4"	20
1331	PEX Adapter, 1" PEX x 3/4" or 1" sweat fitting	16	5907	Brass Pipe Union, 3/4"	17
1332	PEX Tee, 1"	16	5908	Brass Pipe Union, 1"	17
1333	PEX Coupling, 1"	11, 16	5909	Brass Pipe Union, 1-1/4"	17
1334	PEX 90° Elbow, Brass, 1"	16	5918	Fin Comb	27
1335	PEX Crimp Ring, 1"	12	5925	Cinch Tool	27
1336	PEX Adapter, 1/2" PEX x 3/4" MIP fittings	16	5926	PEX Stainless Steel Clamp Crimp Ring, 1"	12
1337	PEX Adapter, 1/2" PEX x 1/2" sweat fitting	16	5927	PEX Stainless Steel Clamp Crimp Ring, 1/2"	12
1338	PEX Tee, 1/2"	16	5978	Central Boiler Clamp, 1"	12
1339	PEX Coupling, 1/2"	16	6054	Temp. Gauge, 1/8" MPT	15
1340	PEX 90° Elbow, Brass, 1/2"	16	6145	Spring, Replacement for 2500053	31
1341	PEX Adapter, 1/2" PEX x 1/2" MIP fittings	16	6172	Elbow, 8", 45-degree	34
1342	PEX Crimp Ring, 1/2"	12	6557	Pipe Plug, Brass 1/2"	17
1348	PEX Adapter, 1/2" PEX x 1/2" FIP fitting	16	6576	Draft Inducer, CL 7260 Dual Fuel (w/fuses)	30
1349	Manifold w/Valves, 2-Loop	15	6593	Grounding Rod Kit	23
1350	Push-fit Temperature Gauge Fitting, 1" x 1/8" NPT	19	6679	Female Adapter, 1/2" barb x 1/2" sweat fittings	16
1360	PEX Piping Mounting Kit	12	6757	Chimney Conversion Adapter, 8"	33
1365-011	Mounting Bracket for 3/4" NPT Thermostatic Valve	21	6764	Brass Offset Tee, 4"	17
1366	Pump Wall Mount Kit	14	6782	Brass Diverter Tee, 1" x 1" x 1/2"	18
1370-011	Mounting Bracket for 1-1/4" NPT Thermostatic Valve	21	6833	Wayne Burner Kit, LP*	32
1548	3/4" NPT Thermostatic Valve Fittings Kit	21	6834	Beckett Burner Kit, oil*	32
1624	1-1/4" NPT Thermostatic Valve Fittings Kit	21	6843	Wayne Burner Kit, LP**	32
1694	Y-Strainer, 1-1/4" Black	8	6844	Beckett Burner Kit, oil**	32
1695	Y-Strainer, 3/4" Brass	8	7594	Door Seal Rope, 1", per ft.	30
1740	Thermostat Kit, 150°F	21	7594	Rope, 1", per foot	35
1745	Central Boiler Clamp, 1-1/4"	12	7632	Rope Ring, 3/4", 8" ID	34
1880	Manifold w/o Valves, 2-Loop	15	7674	Door Seal Rope, 7/8", per ft.	30, 34, 35
1885	Manifold w/o Valves, 3-Loop	15	8402	Chimney Support Brace Kit	34
1910	Fan Convactor, Corner, 7k Btu	6	8656	Wood Moisture Meter Kit	27
1930	2-Stage Gas Regulator Kit	32	8838	Ignitor Burner Gasket	32
1938	Air Filter, 10" x 10" x 1"	6	8863	Seal, 3/16" x 3/4", per ft.	35
1940	Fan Motor	6	8869	Bronze Silicone Adhesive	35
1941	Fan Convactor, Wall Mount, 7k Btu	6	9263	Push-fit Fittings Water Heater Kit	8
1970	Ash Shovel	28	9264	Push-fit Connector, Straight, 3/4" x 3/4" MIP	19
1971	Fan Convactor, 26k Btu	6	9265	Push-fit Elbow, 3/4" x 3/4"	19
2053	Fittings Kit	8	9458	Auxiliary Auger Vibrator w/Timer Kit	24
2441	ThermoPEX, 1", 100' Roll	11	9535	Chimney Band Clamp Kit, 6"	33
2443	ThermoPEX Cap, 1"	11	9623	Side Draft Inducer, Pallet Burner	30
2447	ThermoPEX Coupling Kit, 1"	11	9624	Tee, Brass, 3/4"	17
2491	ThermoPEX, 1", 800' Roll	11	9660	48-Bushel Hopper Kit - Terra Brown and Taupe	24
2492	ThermoPEX, 1-1/4", 300' Roll	11	9691	Hopper Vibrator Kit	24
2494	ThermoPEX Cap, 1-1/4"	11	9760	48-Bushel Hopper Kit - Green and Olive Gray	24
2495	ThermoPEX Coupling Kit, 1-1/4"	11	9804	Bag Holder Kit	24
2656	Pin Extraction Tool	27	10508	8" Chimney Extension, 4'	33

Numerical Parts List

10509	Chimney Snaplock Clamp, 8"	33	2900325	Outdoor Torch	27
10588	Natural Gas Conversion Kit, E-Classic 1400/2400	32	2900341	Universal Crimp Tool, 14-24 AWG	27
10598	Natural Gas Conversion Kit	32	2900393	Wood Moisture Meter, Mini 3-in-1	27
10713	Tape, Blue Teflon, 1/2" x 1429"	17	2900399	Rubber Clamp, Quick Fist, 0.63"-1.38"	29
10895	Chimney Adapter Kit, 10" to 8", For Pallet Burner and CL 7260	34	2900400	Rubber Clamp, Quick Fist, 1.00"-2.25"	29
10970	Chimney Tee Restrictor Kit	34	2900401	Repair Kit, 2-Way Zone Valve, 3/4" and 1"	20
11157	Nipple, Schedule 80, Black, 1-1/4" x 3"	17	2900410-SP	Hose, Braided, 3/4" x 18"	11
11605	10" Chimney Tee Kit	34	2900411-SP	Hose, Braided, 3/4" x 24"	11
11606	Combustion Fan w/Wiring	30	2900485	6" Chimney Brush	28
11618	Combustion Fan	30	2900486	8" Chimney Brush	28
64026	Mixing Valve, 1" x 4-way FNPT	21	2900487	Extension Rod, 48" Fiber	28
1200033-011	Manifold, 1-1/4" Inlet x 3/4" Outlets	15	2900488	Extension Rod, 48" Wire	28
1200034-011	Manifold, 1-1/4" Inlet x 1-1/4" Outlets	15	2900489	Extension Rod, 72" Wire	28
1200037	Chimney Weld Ring, 8"	33	2900490	Handle	28
1200897-011	Afterburner Cleaning Tool	28	2900534	Scraper Tool	28
2000041	Replacement Gear Motor, Auxiliary Auger	24	2900535	Ash Shovel	28
2000127	Heat Exchanger Scraper, E-Classic 1450	28	2900544	Fan Coil Unit, 50k Btu	7
2000128	Heat Exchanger Scraper, E-Classic 3200	28	2900545	Fan Coil Unit, 100k Btu	7
2000320	Outer Control Cover	23	2900546	Fan Coil Unit, 220k Btu	7
2000737	Combustion Fan Assembly	30	2900549	Thermal Actuator, 2-wire	15
2001046	Draft Inducer, Steel Door, CL 7260	30	2900550	Thermal Actuator, 4-wire	15
2001050	Draft Inducer, Steel Door, Pallet Burner	30	2900551	Loop Cap, Manifold	15
2001235	Cleaning Rod, Tempered, 5/8"	28	2900552	Manifold Kit, 2-Loop	14
2500000	LP Gas Burner Kit, E-Classic 1450 IR Models	32	2900553	Manifold Kit, 3-Loop	14
2500001	Natural Gas Conversion Kit, E-Classic IR Models	32	2900554	Manifold Kit, 4-Loop	14
2500002	LP Gas Burner Kit, E-Classic 1400 IR Models	32	2900556	Manifold Kit, 6-Loop	14
2500003	LP Gas Burner Kit, E-Classic 2400 IR Models	32	2900558	Manifold Kit, 8-Loop	14
2500004	LP Gas Burner Kit, E-Classic 3200 IR Models	32	2900560	Manifold Kit, 10-Loop	14
2500005	Battery Clean Out Kit	25	2900562	Manifold Kit, 12-Loop	14
2500007	Auxiliary Auger Kit, 5-1/2'	24	2900563	Connector, Compression, 1/2" PEX	14
2500008	Auxiliary Auger Kit, 6'	24	2900564	Connector, Compression, 1/2" PEX-AL-PEX	14
2500009	Auxiliary Auger Kit, 8'	24	2900578	Hot Water Sediment Trapper Filter, 3/4" FPT	26
2500010	Transformer	6	2900596	Temperature Gauge, Manifold	15
2500011	LP Upper Burner Kit, E-Classic 2300	32	2900597	6" Chimney Cap, Spark Arrestor	33
2500013	Fittings Kit, threaded ports	8	2900598	8" Chimney Cap, Spark Arrestor	33
2500023	FireStar II Wiring Kit	23	2900610	Replacement Fan, motor and shield, 50k Btu, for 29000544	7
2500024	3/4" NPT Thermostatic Valve Kit	21	2900611	Replacement Fan, motor and shield, 100k Btu, for 29000545	7
2500025	1-1/4" NPT Thermostatic Valve	21	2900612	Replacement Fan, motor and shield, 220k Btu, for 29000546	7
2500044	Chimney Base Brace Kit, 6"	34	2900614	Adapter, Manifold, Female 1" NPT	14
2500045	Rear Door Hinge Kit - E-Classic 1450/3200	31	2900617	Ferroin Indicator	26
2500050	Hopper Assembly with Fuel Door Kit - M250/M255 P	25	2900618	CAN Solution	26
2500053	Spring-Assisted Linkage, All Linkage Models	31	2900619	PEX Pipe Cutter	27
2500070	FireStar XP Outdoor Wi-Fi Module Kit	23	2900630	MolyArmor 350 Corrosion Inhibitor	26
2500073	Transfer Auger with Fuel Door Assembly Kit - M175	25	3104665	Mounting Bracket, 55k Btu Pool Heat Exchangers	9
2500143	Backup Battery Replacement	25	3104940	Mounting Bracket, 155k/300k/360k Btu Pool Heat Exchangers	9
2500144	LED Light Kit	23	3104941	Mounting Bracket, 600k Btu Pool Heat Exchangers	9
2500145	Secondary LED Light Kit	23	3104942	Mounting Bracket, 1200k Btu Pool Heat Exchangers	9
2500153	Bypass Alarm Kit, Classic Edge 750	24	3105186-011	Heat Exchanger Cleaning Tool	28
2500172	ThermoPEX Coupling Kit, 25mm	11	4050036	Foam Bumper Pad, Door Switch - Classic Edge and Forge models	30
2500185	FireStar XP Outdoor Wi-Fi Module Kit	23	5000015	Nipple, Schedule 80, Black, 1-1/4" x 2-1/2"	17
2500198	Cleaning Rod Scraper Attachment	29	5000016	90° Elbow, Black, 1-1/4"	17
2500244	6" Chimney Tee Kit	34	5000017	45° Street Elbow, 1-1/4"	17
2500245	8" Chimney Tee Kit	34	5000018	Nipple, Schedule 80, Black, 3/4" x 3"	17
2500296	Chimney Cleaning Kit, 6"	28	5000083	Purge Tee, Drain, Brass, 3/4" female	20
2500297	Chimney Cleaning Kit, 8"	28	5000378	Valve Head, 1/2" Vertical, TRV II	10
2500299	Heat Exchanger Mounting Kit	8	5000380	1" Stainless Steel PEX Clamp	12
2500358	Corn Aerator Kit	24	5000392	Water Heater Mixing Valve, 3/4" NPT fittings, lead free	21
2500359	Corn Aerator Paddle Kit	24	5000394	Nipple, Brass, 3/4" x 4"	17
2500374	Integrated Cleaning System, Classic Edge 350/550	29	5000462	PEX Coupling, 25mm	16
2500375	Integrated Cleaning System, Classic Edge 750	29	5000464	PEX Adapter, 25mm x 3/4" MIP	16
2500390	Draft Inducer, Flat Front Steel Door, CL 4030, 5036, 6048	30	5000465	PEX Stainless Steel Clamp Crimp Ring, 25mm	12
2500398	24V Fan Conversion Kit	23	5000472	Backflow Preventer, LF, 3/4"	20
2500415	Kit, Water Sample Bottle	26	5000531	PEX Adapter, 1" PEX x 3/4" MPT fittings, 90° Elbow	16
2500416	6" Chimney Tee Kit	34	5000556	Ball Valve, 1/2" PEX, Full Port	20
2500428	External Wi-Fi Antenna Mount Kit	23	5000557	Ball Valve, 1" PEX, Full Port	20
2500433	8" Chimney Tee Kit	34	5000638	PEX Stainless Steel Hose Clamp, 25mm	12
2500620	6" Chimney Tee Kit	34	5000651	PEX Adapter, 1" PEX x 1" sweat fitting	16
2500621	8" Chimney Tee Kit	34	5000661	Ball Valve, 1"	20
2500633	24V Fan Conversion Kit	23	5000670	Flow Check Valve, 1" Cast Iron	20
2500640	Draft Inducer, Steel Door, CL 7260 High Output	30	5000673	O-Ring, Manifold	14
2500641	Door Seal Kit - Classic Edge 350/360	30	5000683	O-Ring, Replacement, for Hot Water Filter (p/n 2900578)	26
2500642	Door Seal Kit - Classic Edge 550/560, E-Classic 1400/1450	30	5000700	Brass Hose Bib w/Cap and Chain, 3/4" FIP x 3/4" Hose	20
2500643	Door Seal Kit - Classic Edge 750/760	30	5000768	PEX Swoop Elbow, 90°	16
2500644	Door Seal Kit - Classic Edge 960, E-Classic 2300, 2400/3200/3250	30	5500014	ThermoPEX Cap, 25mm	11
2500691	Moly/pH Test Kit, Complete	26	5600000	Myson Whispa III Kickspace 9000 Fan Convactor	7
2900001	Hoe, Firebox, 72"	28	5600001	Plate Exchanger, 5 x 12-50, 1-1/4" Port	8
2900002	PEX Piping Clip Gun	27	5600002	Plate Exchanger, 5 x 12-70, 1-1/4" Port	8
2900003	PEX Piping Clips, 100 qty.	12	5600003	Plate Exchanger, 5 x 12-6, 3/4" Port	8

Numerical Parts List

5600005	Pool Heat Exchanger, 316L, 55k Btu	9	5800027	2-Way Zone Sentry Zone Valve, 1" sweat	20
5600006	Pool Heat Exchanger, 316L, 155k Btu	9	5800028	3-Way Zone Sentry Zone Valve, 1" sweat	20
5600007	Pool Heat Exchanger, 316L, 300k Btu	9	5800030	3-Way Zone Sentry Zone Valve, 3/4" sweat	20
5600008	Pool Heat Exchanger, 316L, 360k Btu	9	5800033	Pump, Taco 0015e3	13
5600009	Pool Heat Exchanger, 316L, 600k Btu	9	5800034	O-Ring, Cartridge, Taco 007/009 (set of 2)	13
5600010	Pool Heat Exchanger, 316L, 1200k Btu	9	5800041	Replacement Temp. Sensor	13
5600011	Pool Heat Exchanger, Titanium, 55k Btu	9	6000033	Rope Ring (only), 2" Low Density Braid, 8" I.D.	34
5600012	Pool Heat Exchanger, Titanium, 155k Btu	9	6000034	Rope Ring (only), 1.75" Low Density Braid, 6" I.D.	34
5600013	Pool Heat Exchanger, Titanium, 300k Btu	9	6000064	Door Seal, Silicone-Coated, 7/8", 100-ft	30
5600014	Pool Heat Exchanger, Titanium, 360k Btu	9	6500004	6" Chimney Extension, 4'	33
5600015	Pool Heat Exchanger, Titanium, 600k Btu	9	6500011	Chimney Snaplock Clamp, 6"	33
5600018	Water-to-Water Heat Exchanger, 33"	8	8200008	Non-programmable 24-Volt Thermostat	6
5600019	Plate Exchanger, 10 x 20-55, 1-1/4" Port	8	8200080	Wi-Fi Antenna only	23
5600021	Panel Radiator, 32" x 16"	10	8200291	Switching Relay, Single Zone	14
5600022	Panel Radiator, 36" x 24"	10	8200293	Power Relay, 24V, SPNO-SPNC	22
5600023	Panel Radiator, 48" x 24"	10			
5600025	Panel Radiator, 36" x 24"	10			
5600026	Panel Radiator, 24" x 16"	10			
5600027	Panel Radiator, 48" x 16"	10			
5600028	Panel Radiator, 32" x 20"	10			
5700034	ThermoPEX, 1", 200' Roll	11			
5700043	ThermoPEX, 25mm, 60' Roll	11			
5700045	ThermoPEX, 25mm, 500' Roll	11			
5700046	ThermoPEX, 25mm, 95' Roll	11			
5700047	ThermoPEX, 25mm, 55' Roll	11			
5700082	Central PEX 1" Pipe, 8' straight section, 10 per bag	11			
5700083	Central PEX 1" Pipe, 8' straight section, 25 per bag	11			
5800004	Taco 007 Pump	13			
5800005	Replacement Cartridge, Bronze, 007 Series Pumps	13			
5800006	Taco 009 Pump	13			
5800007	Replacement Cartridge, 009 Series Pumps	13			
5800008	Taco 014 Pump	13			
5800009	Replacement Cartridge, 014 Series Pumps	13			
5800010	Replacement Cartridge, Bronze, 011 Series Pumps	13			
5800011	Taco 007 Priority Pump	13			
5800019	Pump Flange Kit, 1-1/4"	14			
5800020	2-Way Zone Sentry Zone Valve, 3/4" NPT threads	20			
5800021	3-Way Zone Sentry Zone Valve, 3/4" NPT threads	20			
5800022	Replacement Acuator Head for Sentry Zone Valve	20			
5800023	Taco Viridian Pump, VR1816F	13			
5800025	Taco Viridian Pump, VT2218	13			